



PLATE ROLLS



HR-4, HRR-4, HR-3, VR-3, MR, VMR SERIES



Anerka was established in Bursa / Turkey in 2016 by Atakan Nerminer and Ramazan Kaba who has more than 20 years of experience in the design and production of roll bending and profile bending machines. We produce plate roll bending machines from 1mm to 100mm with 3 or 4 rolls, motorized or hydraulic, manual, NC or CNC control units in a wide range of products. We export 70% of our production to the US market.

Our 4 roll plate roll bending machines are advanced bending and rolling machines as they are more precise, productive, versatile, faster, safer and easier to operate. They are ideal for rolling metal plate from 3mm steel all the way up to up to whopping 100mm thick metal plates. The fastest and most accurate bends are made on our four roll plate rollers. The plate is held securely in place between the top and bottom induction hardened rolls while the side rolls move vertically to create an accurate bend easily, intuitively and quickly. All of our 4 roll plate rolling machines can roll sheet metal as fast as 5m per minute, bringing you the most high-tech in high productive mid range to heavy plate rollers on the market. ANERKA is proud to say that all of the plate roller machines we produce are high quality production machines that comply with the tight ISO 9001:2015 certification standards which are a MUST in today's competitive environments.

Why Should You Consider a 4 Roll Plate Roller Over a 3 Roll Machine?

With our 4 roll machines the bottom roll moves up to pinch the plate edge securely against the top roll while the side roll is raised to form an accurate pre-bend, minimizing the flat zone on the plate edge. Pre-bending on a three roll machine requires that plates be tilted down as they are being fed. In contrast, plates are loaded horizontally at the feed level for pre-bending on our four roll machine, which allows the use of horizontal motorized roller tables to help feed the plate. Plate feeding can take place on either side of our four roll machine. If fed from only one side, they can even be placed up against a wall to save floor space. The side rolls are positioned to the right and left of the bottom roll and are on their own axes. The independent axis of each roll helps make a perfect bend. The "back" side roll (at the far side of the feeding point) also functions as a back gauge to square the plate for proper alignment. This eliminates the need for someone to assist the operator. The plate is kept square without slipping during both pre-bending and rolling because of the constant secure clamping of the top and bottom rolls.

What is the ideal plate roll for cone bending?

Cone rolling is easier on a four roll machine. The side rolls can be tilted to establish the cone angle and the bottom roll can also be tilted to clamp and drive the plate. Our HR-4 series plate rolls are designed to utilize planetary guides. Our HRR-4 series plate rolls are controlled by rectilinear guides that provide the controlled movement required to create accurate bends and this design increases the longevity of the machines life. This system allows bending of as small as 1.1 times the diameter of the top roll, providing the tightest bend radius in the industry. Through superior construction and design, a massive heavy weight frames and the ability to angle bottom and side rolls our 4 roll plate roller can bend wide angle and small diameter conical parts with ease, with minimal effort from the operator. While most machines on the market can conically bend three times the diameter of the top roll, ours can conically bend 1.5 times the diameter of the top roll and frequently smaller diameters than that. Roll cones like a seasoned plate roll operator.



Ramazan KABA

Atakan NERMINER

BENEFITS OF **FOUR ROLL** BENDING MACHINES

- The fastest and most accurate bends are made by four roll machines. The plate is held securely in place between the top and bottom rolls while the side rolls move vertically to create the bend.
- The bottom roll moves up to hold the plate edge securely against the top roll while the side roll is raised to form an accurate pre-bend, minimizing the flat zone on the plate edge. Pre-bending on a double pinch three roll machine requires that plates be tilted down as they are being fed. In contrast, plates are loaded horizontally at the feed level for pre-bending on a four roll machine, which allows the use of horizontal motorized roller tables to help feed the plate.
- Plate feeding can take place on either side of a four roll machine. If fed from only one side, they can even be placed up against a wall to save floor space.
- The side rolls are positioned to the right and left of the bottom roll and are on their own axes. The independent axis of each roll helps make a perfect bend. The “back” side roll (at the far side of the feeding point) also functions as a back gauge to square the plate for proper alignment (see figure 1). This eliminates the need for someone to assist the operator.
- The plate is kept square without slipping during both pre-bending and rolling because of the constant secure clamping of the top and bottom rolls.
- Four roll machines do not require the operator to remove, flip, and then try to square the plate a second time after pre-bending, as is the case with three roll initial pinch (IP) machines. Keeping the material in the machine makes four rolls 50% more efficient than three roll IP machines, and allows a cylinder to be rolled to the required diameter immediately following pre-bending.
- Bending the back edge takes place after the cylinder is rolled, for a one direction, single pass operation.
- Cone rolling is easier on a four roll machine. The side rolls can be tilted to establish the cone angle and the bottom roll can also be tilted to clamp and drive the plate.
- Four roll machines are the only type of plate rolls that can effectively make use of NC and CNC controls because of the constant clamping and driving of the material during all steps of rolling. Bending difficult shapes like polycentric or elliptic work pieces can be easily done with CNC four roll machines.

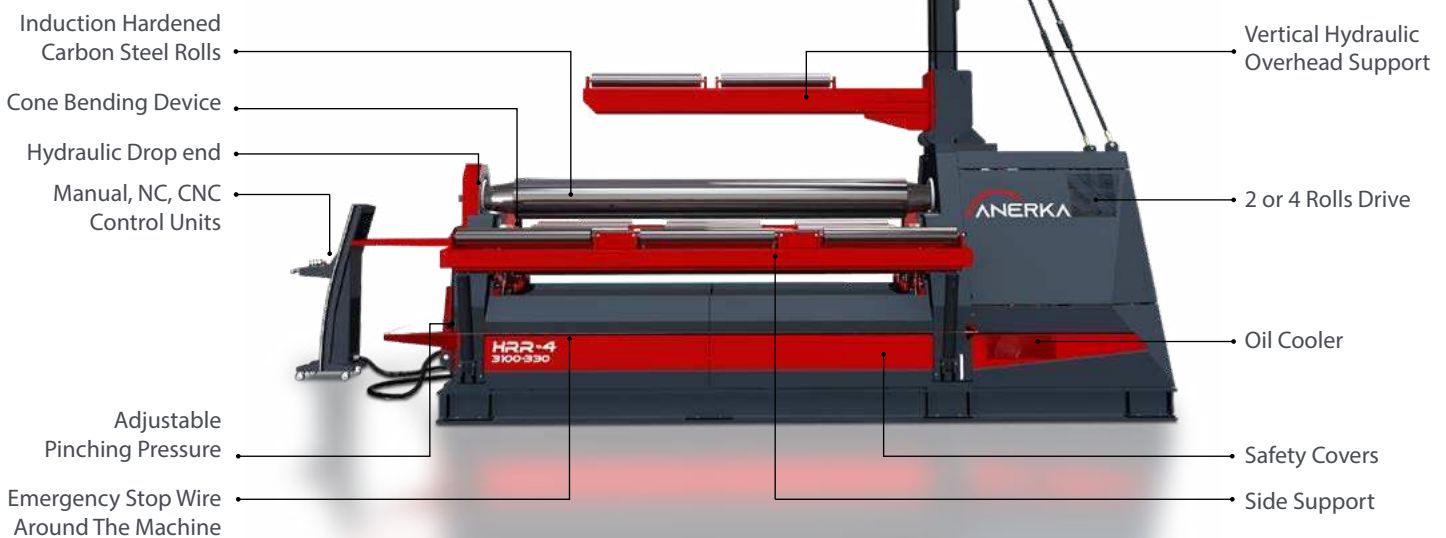
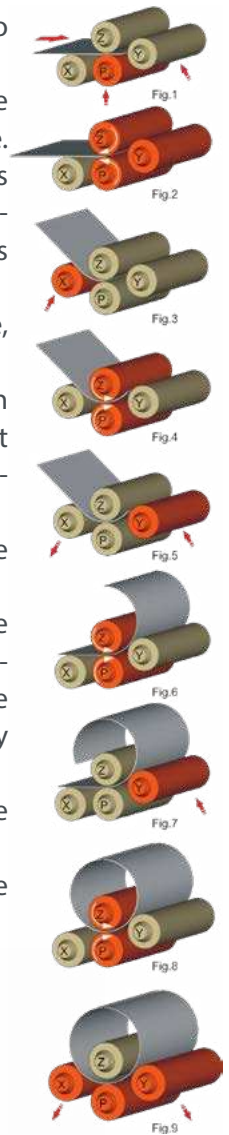

With many solutions available, we can configure any machine to exactly match your requirements.

HR-4 SERIES

Planetary Type Hydraulic Four Roll
Light and Mid Plates, High Volume
1,2~ 4m Bending Lengths
Ø140 ~ Ø430 Top roll diameter
2 ~ 44mm Capacity
See pages 19-22.



HRR-4 SERIES

Rectilinear Type Hydraulic Four Roll
Mid and Heavy Plates, High Volume
2 ~ 4m Bending Lengths
Ø330~ Ø760 Top roll diameter
8 ~ 95mm Capacity
See pages 23-26.



HR-3 SERIES

Planetary Type Hydraulic Three Roll
Versatile, Mid Plates, Job Shops
2~ 4m Bending Lengths
Ø200 ~ Ø430 Top roll diameter
4 ~ 44mm Capacity
See pages 27-29.



VR-3 SERIES

Variable Geometry Hydraulic Three Roll
Mid and Heavy Plates, Rolling Shops
2,5~ 4m Bending Lengths
Ø350 ~ Ø680 Top roll diameter
10 ~ 85mm Capacity
See pages 30-34.



MR SERIES



Motorized Initial Pinch Three Roll Light Sheets, Low Volumes

These initial pinch rolls are designed for small part bending with low operation cost. MR rolls feature robust steel frames, chain and gearbox drive systems and electric motors with a magnetic break which eliminates drifting. They also offer foot pedals with forward, reverse, and emergency stop along with a safety wire and limit switch. A very economical, reliable, and efficient choice for your small parts needs. See pages 35-40.



MRA Series

1m ~ 2m Bending Lengths
68mm ~ 75mm Top roll diameter
Up to 2mm Capacity



MRB Series

1m ~ 2m Bending Lengths
90mm ~ 100mm Top roll diameter
Up to 3mm Capacity









































MRC Series

1m ~ 2,5m Bending Lengths
110mm ~ 140mm Top roll diameter
Up to 5,5mm Capacity



MRD Series

1m ~ 3m Bending Lengths
150mm ~ 180mm Top roll diameter
Up to 10mm Capacity

		MR	HR-3	VR-3	HR-4	HRR-4
Rolls		3	3	3	4	4
Bending Length Range		1-3m	2-4m	2,5-4m	1,2-4m	2-4m
Top Roll Diameter		68-180mm	200-430mm	350-680mm	140-430mm	330-760mm
Thickness Range		Up to 9mm	Up to 44mm	Up to 85mm	Up to 44mm	Up to 100mm
Custom Lengths and Thickness		O	O	O	O	O
Obtainable Production Tolerances	Fine					
	Excellent					
Part Geometries (without experienced operator)	Simple 					
	Moderate 					
	Complex 					
Production Speed	Medium					
	High					
Controls	Digital Read-out	O	N/A	N/A	N/A	N/A
	PLC	N/A	S	S	S	S
	NC	N/A	N/A	O	O	O
	CNC	N/A	N/A	N/A	O	O
Software	ESA Offline Simulator (Available on CNC models)	N/A	N/A	N/A	O	O
Frame	Solid Steel Frame	S	N/A	N/A	N/A	N/A
	Stress Relieved Steel Construction	N/A	S	S	S	S
Rolls	AISI 1050 Carbon Steel Rolls	S	S	S	S	S
	AISI 4140 High Strength Alloy Steel Rolls	O	O	O	O	O
	Induction hardening + Polish	O	S	S	S	S
	Induction hardening + Ground	O	O	O	O	O
Rolls Drive System	Electrical Motor + Gearbox (Top - Bottom Rolls)	S	N/A	N/A	N/A	N/A
	Hydraulic Motor + Planetary Gearbox (Top Roll)	N/A	N/A	S	N/A	N/A
	Hydraulic Motor + Planetary Gearbox (Top & Bottom Rolls)	N/A	N/A	N/A	S	S
	Hydraulic Motor + Planetary Gearbox (All Rolls)	N/A	S	N/A	O	O
Roll Positioning System	Manual Bottom & Side Roll	S	N/A	N/A	N/A	N/A
	Motorized Side Roll	O	N/A	N/A	N/A	N/A
	Motorized Side Roll (MRD Series)	S	N/A	N/A	N/A	N/A
	Motorized Bottom Roll	O	N/A	N/A	N/A	N/A
	Hydraulically Acted with Electronically Positioned and Synchronized Bottom / Side Rolls	N/A	S	S	S	S

S = Standard / O = Option / N/A = Not Applicable

		MR	HR-3	VR-3	HR-4	HRR-4
Safety	Safety Wire Around the Machine and Emergency Stop Button	S	S	S	S	S
Lubrication Systems	Manual lubrication	S	S	S	S	S
	Automatic central lubrication	N/A	O	O	O	O
Oil Cooler / Heater	Oil Cooler	N/A	O	O	O	O
	Oil Heater	N/A	O	O	O	O
Variable Speed	Variable Speed for Roll Rotation (Std. on CNC Control)	N/A	O	O	O	O
Special Color	Special Color	O	O	O	O	O
Air Conditioning	Air Conditioning for Electrical panel	N/A	O	O	O	O
Hydraulic Vertical Overhead Support Systems	Preparation for vertical support system	N/A	O	O	O	O
	Vertical support - Hydraulic	N/A	O	O	O	O
	NC inclusion for vertical support control (Available on CNC control)	N/A	N/A	N/A	O	O
Hydraulic Side Support Systems	Preparation for side support system	N/A	O	O	O	O
	Side Support System (Both Side)	N/A	O	O	O	O
	NC inclusion for side support control (Available on CNC control)	N/A	O	N/A	O	O
Feeding Systems	Material Feeding Table - L=3m	N/A	O	O	O	O
	Material Feeding Table - Motorised - L=3m	N/A	O	O	O	O

BENDING CAPACITIES AND CALCULATIONS

Our machines capacities are defined for (260 N/mm²) yield strength plates on multistep bending. For different yield, length and thickness plates you can use "Bending Capacity Chart"

HR-4 3100-330		Bending Capacity Chart																						
BENDING LENGTH (mm)		3000																						
PREBENDING CAPACITY (mm)		16																						
ROLLING CAPACITY (mm)		20																						
TOP ROLL DIAMETER (mm)		330																						
PLATE WIDTH		3000 100% Width		2700 90% Width		2400 80% Width		2100 70% Width		1800 60% Width		1500 50% Width		1200 40% Width		900 30% Width		600 20% Width						
MATERIAL TYPES		Inside Diameter	Pre-Bending Thickness	Rolling Thickness	Pre-Bending Thickness	Rolling Thickness	Pre-Bending Thickness	Rolling Thickness	Pre-Bending Thickness	Rolling Thickness	Pre-Bending Thickness	Rolling Thickness	Pre-Bending Thickness	Rolling Thickness	Pre-Bending Thickness	Rolling Thickness	Pre-Bending Thickness	Rolling Thickness	Pre-Bending Thickness	Rolling Thickness				
CLASS-1 MATERIAL Max Yield Strength	207	30,000	363	14.6	16.2	15.4	17.0	16.4	18.1	17.5	19.3	18.9	20.9	20.7	22.9	23.2	25.5							
			429	15.5	16.7	16.4	17.6	17.3	18.7	18.5	20.0	20.0	21.6	21.9	23.6	24.5	26.4					30.5		
			495	16.4	17.1	17.3	18.0	18.3	19.1	19.6	20.4	21.1	22.0	21.1	22.0	23.2	24.1	27.0					31.2	
			660	17.2	17.5	18.2	18.4	19.3	19.5	20.6	20.9	22.2	22.5	24.4	24.7	27.6							31.9	
			990	17.8	18.5	18.8	19.5	19.9	20.7	21.3	22.1	23.0	23.9	25.2	26.2	29.3								
CLASS-2 MATERIAL Max Yield Strength	248	36,000	1320	19.0	19.7	20.0	20.8	21.2	22.1	22.7	23.6	24.5	25.5	27.9							31.2			
			1650	20.3	21.5	21.4	22.7	22.7	24.1	24.3	25.7	27.8												
			3300	21.5	23.3	22.7	24.6	24.1	26.1	27.9														
			363	13.6	15.0	14.3	15.8	15.2	16.8	16.3	17.9	17.6	19.4	19.2	21.2	21.5	23.7					24.8	27.4	
			396	14.4	15.5	15.2	16.3	16.1	17.3	17.2	18.5	18.6	20.0	20.4	21.9	22.8	24.5						28.3	
CLASS-3 MATERIAL Max Yield Strength	345	50,000	495	15.2	15.8	16.0	16.7	17.0	17.7	18.2	18.9	19.6	20.4	21.5	22.4	24.0	25.0					28.9		
			660	16.0	16.2	16.9	17.1	17.9	18.1	19.1	19.4	20.7	20.9	22.6	22.9	25.3	25.6					29.6		
			990	16.6	17.2	17.5	18.1	18.5	19.2	19.8	20.6	21.4	22.2	23.4	24.3	27.2							31.4	
			1320	17.6	18.3	18.6	19.3	19.7	20.5	21.0	21.9	22.7	23.7	24.9	25.9	29.0								
			1650	18.9	20.0	19.9	21.1	21.1	22.4	22.6	23.9	24.4	25.8	28.3										
CLASS-4 MATERIAL Max Yield Strength	689	100,000	3300	20.0	21.7	21.1	22.8	22.4	24.2	23.9	25.9	28.0												
			363	11.3	12.5	12.0	13.2	12.7	14.0	13.6	15.0	14.6	16.2	16.0	17.7	17.9	19.8	20.7	22.9			25.4	28.0	
			429	12.0	12.9	12.7	13.6	13.4	14.5	14.4	15.5	15.5	16.7	17.0	18.3	19.0	20.4	21.9	23.6				28.9	
			495	12.7	13.2	13.4	13.9	14.2	14.8	15.2	15.8	16.4	17.1	17.9	18.7	20.1	20.9	23.2	24.1				29.6	
			660	13.3	13.5	14.1	14.2	14.9	15.1	16.0	16.2	17.2	17.5	18.9	19.1	21.1	21.4	24.4	24.7				30.2	
HIGH YIELD	689	100,000	990	13.8	14.4	14.6	15.1	15.4	16.0	16.5	17.2	17.8	18.5	19.5	20.3	21.8	22.7	25.2	26.2			28.1		
			1320	14.7	15.3	15.5	16.1	16.4	17.1	17.6	18.3	19.0	19.7	20.8	21.6	23.2	24.2	27.9				29.9		
			1650	15.8	16.7	16.6	17.6	17.6	18.7	18.8	19.9	20.3	21.5	22.3	23.6	24.9	26.4						30.5	
			3300	16.7	18.1	17.6	19.1	18.7	20.2	19.9	21.6	21.5	23.3	23.6	25.6	28.6								
			363	10.0	11.0	10.5	11.6	11.1	12.3	11.9	13.1	12.8	14.2	14.1	15.5	15.7	17.4	18.2	20.0			22.3	24.5	
HIGH YIELD	689	100,000	429	10.5	11.3	11.1	12.0	11.8	12.7	12.6	13.6	13.6	14.6	14.9	16.0	16.7	17.9	19.2	20.7			23.6	25.4	
			495	11.1	11.6	11.7	12.2	12.4	13.0	13.3	13.9	14.4	15.0	15.7	16.4	17.6	18.3	20.3	21.2			24.9	25.9	
			660	11.7	11.9	12.3	12.5	13.1	13.3	14.0	14.2	15.1	15.3	16.6	16.8	18.5	18.7	21.4	21.6				26.5	
			990	12.1	12.6	12.8	13.3	13.5	14.1	14.5	15.0	15.6	16.2	17.1	17.8	19.2	19.9	22.1	23.0				28.1	
			1320	12.9	13.4	13.6	14.1	14.4	15.0	15.4	16.0	16.6	17.3	18.2	19.0	20.4	21.2	23.5	24.5				30.0	
HIGH YIELD	689	100,000	1650	13.8	14.6	14.6	15.4	15.4	16.4	16.5	17.5	17.8	18.9	19.5	20.7	21.8	23.1	25.2	26.7					
			3300	14.6	15.9	15.4	16.7	16.4	17.7	17.5	18.9	18.9	20.5	20.7	22.4	23.1	25.1	28.9						
			363	8.0	8.8	8.5	9.3	9.0	9.9	9.6	10.6	10.4	11.4	11.3	12.5	12.7	14.0	14.6	16.2			17.9	19.8	
			429	8.5	9.1	9.0	9.6	9.5	10.2	10.2	10.9	11.0	11.8	12.0	12.9	13.4	14.5	15.5	16.7	19.0			20.4	20.4
			495	9.0	9.3	9.5	9.9	10.0	10.4	10.7	11.2	11.6	12.1	12.7	13.2	14.2	14.8	16.4	17.1	20.1			20.9	20.9
HIGH YIELD	689	100,000	660	9.4	9.6	10.0	10.1	10.6	10.7	11.3	11.4	12.2	12.3	13.3	13.5	14.9	15.1	17.2	17.5			21.1	21.4	
			990	9.8	10.1	10.3	10.7	10.9	11.3	11.7	12.1	12.6	13.1	13.8	14.4	15.4	16.0	17.8	18.5			21.8	22.7	
			1320	10.4	10.8	10.9	11.4	11.6	12.1	12.4	12.9	13.4	14.0	14.7	15.3	16.4	17.1	19.0	19.7			23.2	24.2	
			1650	11.1	11.8	11.7	12.4	12.5	13.2	13.3	14.1	14.4	15.2	15.8	16.7	17.6	18.7	20.3	21.5	24.9			26.4	26.4
			3300	11.8	12.8	12.4	13.5	13.2	14.3	14.1	15.3	15.2	16.5	16.7	18.1	18.7	20.2	21.5	23.3					

Due to our ongoing product development, the specifications given in this catalog are subject to change without notice.

ROBUST STEEL STRUCTURE

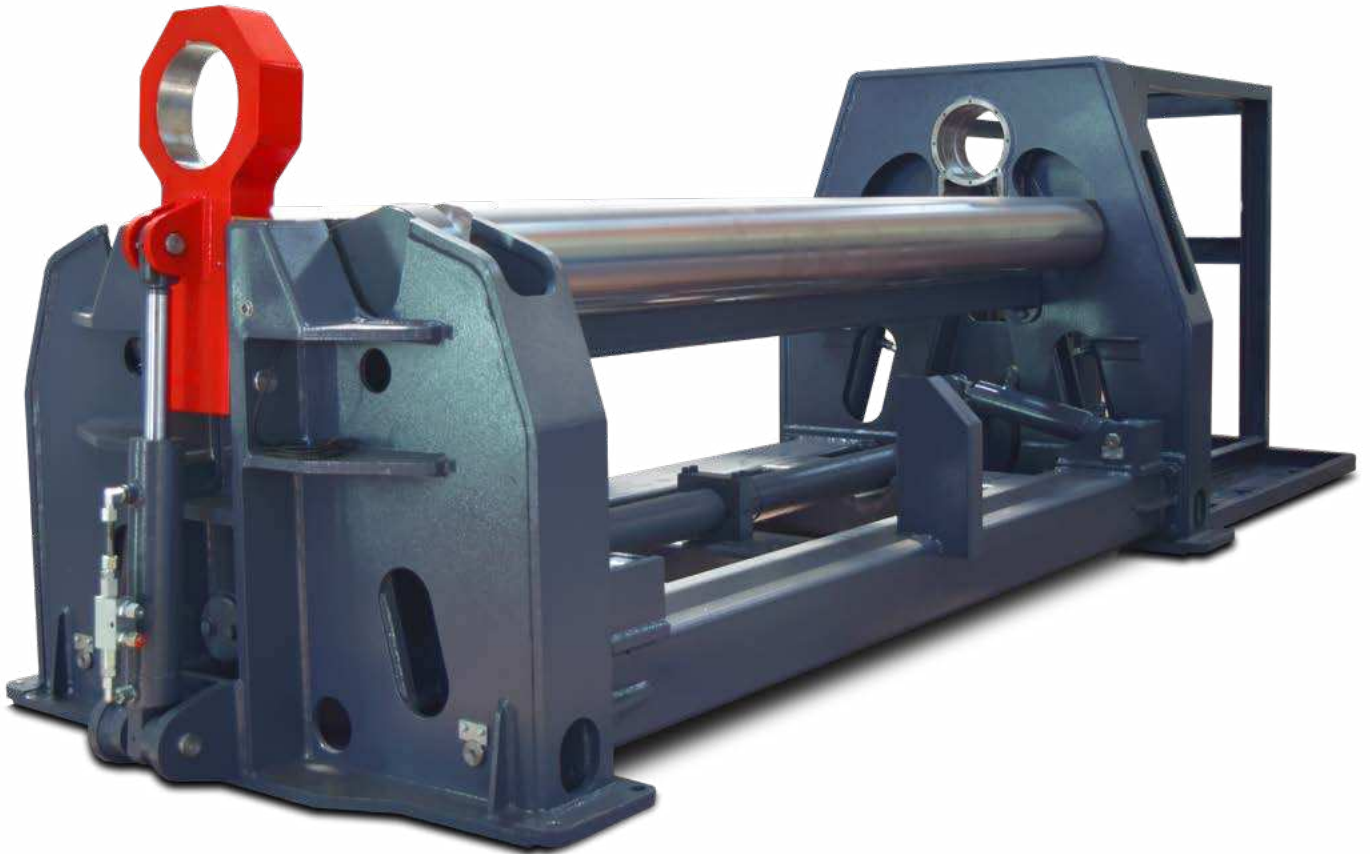

Precision of the roll bending machines depends on the robustness of the frames and chassis. Anerka roll bending machines are designed with box construction with heavy metal plates. The frames are connected to each other by a strong box design chassis that can meet the torsional moments very well instead of sitting on a simple design H or U beams. Frames and chassis are stress relieved after the welding operation. The whole body is machined with 5-axis CNC machining centers utilizing a fixed single reference point. This allows for parallelism of all axes and precise surfaces, as well as longevity and precision of the critical characteristics of the machine.



ROLLS & CROWNING



The most important elements of a plate roll machine are the rolls themselves. Most machines in the market have smaller diameter, weak rolls that deform during the pre-bending process and create a flat spot on the plate edge.

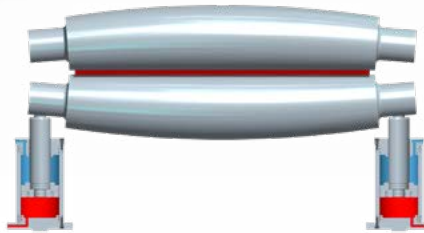

Bending thickness is compatible with roll crowning

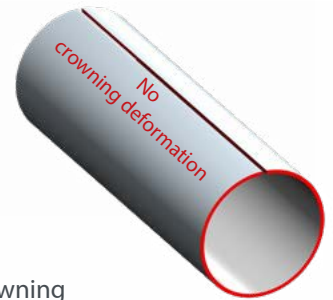

ANERKA designed the rolls with larger diameter and uses high tensile forged steel rolls that are machined by high precision CNC lathes. The working surfaces of the rolls are CNC induction hardened to HRC 54-58 (5-6 mm depth) with hardness tests performed at varying points on the rolls. The smallest bending diameter of 1.1 x top roll diameter is easily achieved.

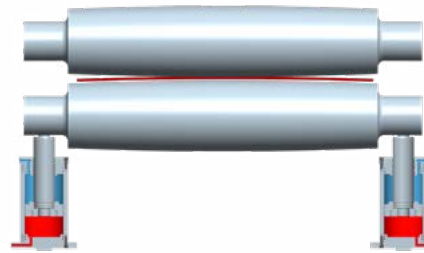

Bending thickness is thinner than roll crowning

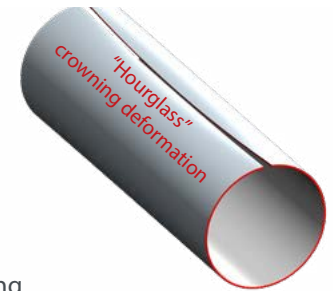

The rolls are machined with a crown to compensate for roll deflection during the pre-bending process. Custom crown machined rolls for different materials or thickness can be applied free of charge when ordering.

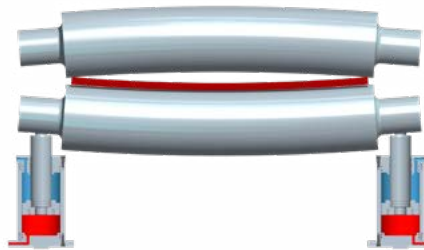

Bending thickness is thicker than roll crowning



OPTIONAL DYNAMIC ROLL CROWNING

In some cases, plate thicknesses can be a very wide range. In this case, it is necessary to eliminate the crowning problems with the dynamic roll crowning system. The system basically serves only to support the rollers for thin plates, while bending thick plates, the hydraulic crowning cylinder apply negative crown to rollers from bottom to eliminate the deflection that may occur during pre-bending. This system helps to get smoother pre-bend edge.

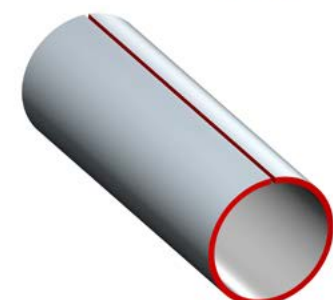
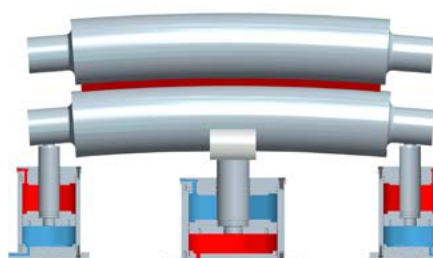
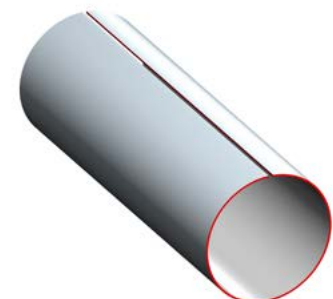
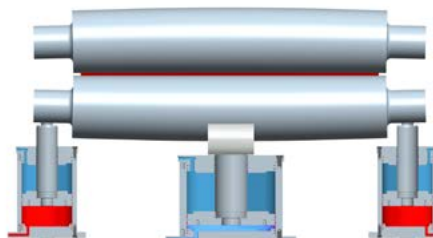

HYDRAULIC DROP END

Hydraulic drop ends on HR-4 series 4 Rolls - allow for easy removal of formed pieces. Cone snubber is a standard feature that is placed on a top roll bearing allowing easy rotation of snubber (so it can not interfere with extraction)

On our HRR-4 series 4 Rolls - the heavy duty roller snubber system is mounted to the main frame of the machine. The top roll is hydraulically tilted up to allow for easy removal of formed parts.

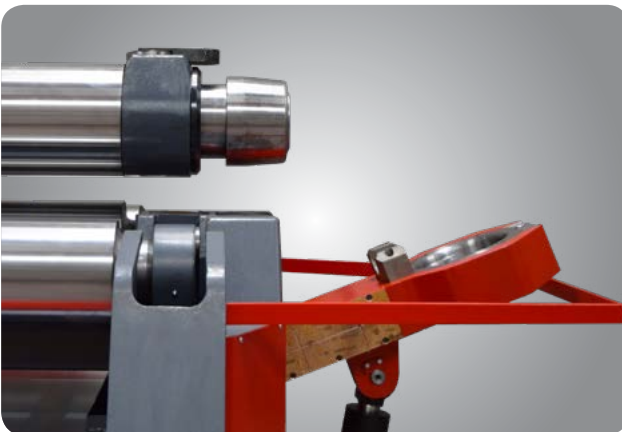
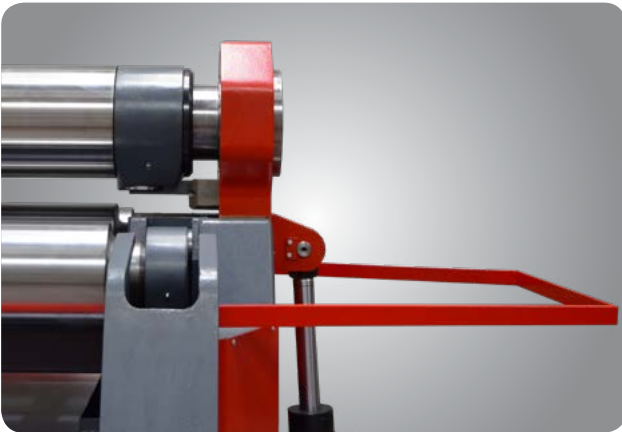

HR-4 Series: Fixed top roll

HRR-4 Series: Tilttable top roll

CONE BENDING

Through superior construction, a massive body and the ability to angle the bottom and side rolls, you can easily bend wide angle and small diameter conical parts.

While most machines on the market can conically bend 3 times the diameter of the top roll, ANERKA 4 roll plate bending machines can conically bend 1.5 times the top roll diameter (or tighter).

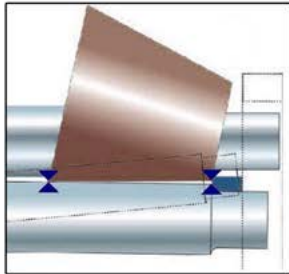

Roller type cone
snubber
HR-4



Roller type cone
snubber
HRR-4

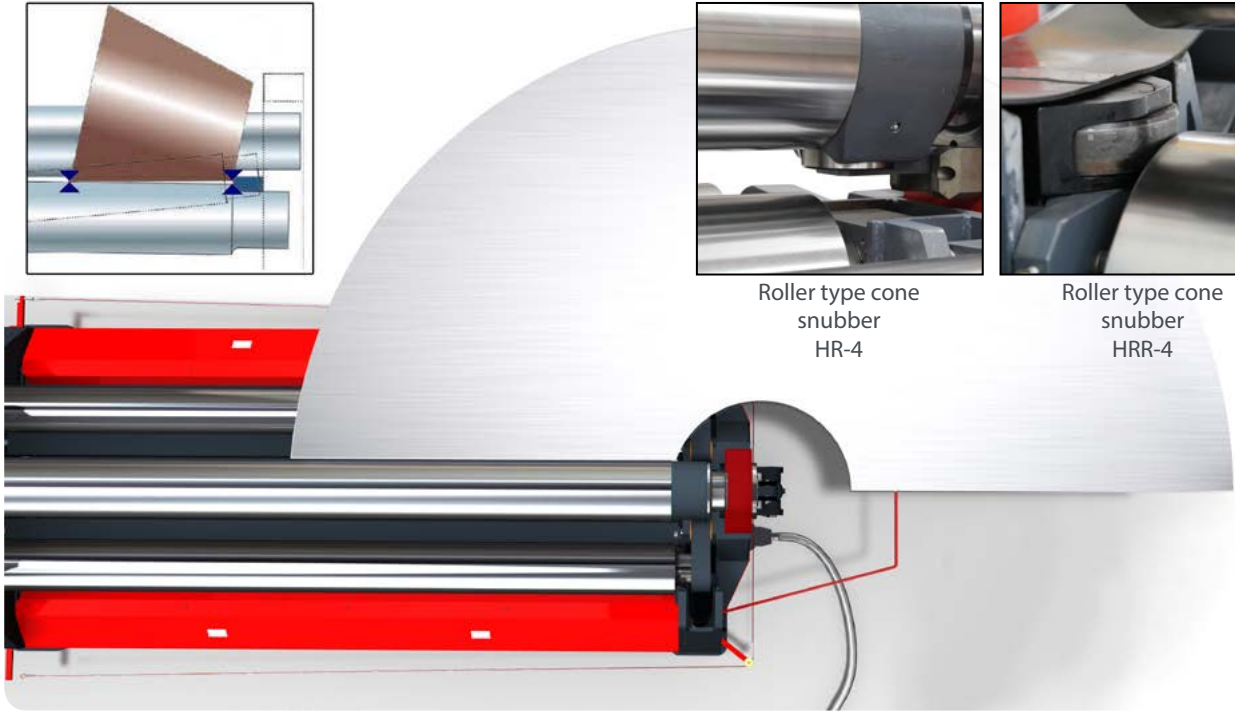

HYDRAULIC & ELECTRIC SYSTEM

Our HR-3, VR-3, HR-4 and HRR-4 series plate roll bending machines movements are actuated by hydraulic components. The precision of all axes are acquired by world leader Duplomatic valve's high speed response ability along with pressure safety valves used against peak pressures and overload, provides protection for motors and other components. The electrical system is designed to be compatible with CE safety regulations. The system consists of well known electrical components such as Siemens, Schneider, Omron and Opkon.



HIGH TORQUE DRIVE SYSTEM

With its high torque, ANERKA plate rolls can bend the sheet with fewer steps. Rolls are driven by directly coupled independent high torque M+S hydraulic motors and Bonfiglioli planetary gearboxes.

A drive system is positioned on the same axis as the roll, which transfers the torque to the plate without losing torque. Some of the machines in the market has universal cardan joints but we prefer direct drive and this is the best power transmission with less backlash. Strong Hydraulic Brakes : Especially during the pre-bend, our system does not allow the sheet to slip back and create safety problems.

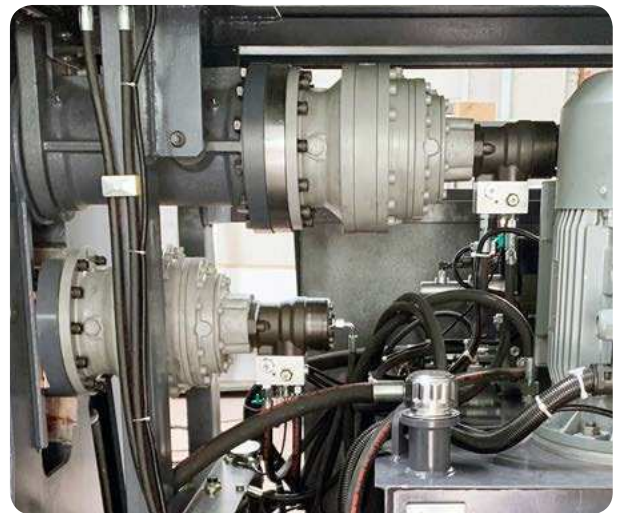

IDEAL PLATE PINCHING

In HR-4 series roll bending machines, plates clamping is achieved by a robust torsion bar which moves the lower roll. Torsion bar is driven by 2 hydraulic cylinders ensures the best parallel pinch of the plate. With a third hydraulic cylinder on the torsion bar is tilt the lower roll when the cone bending.

In the HRR-4 series, the lower roll is acted by strong hydraulic cylinders at the both ends. Synchronization between each other is ensured by electronically with in 0.1mm tolerance.



OPTIONAL SIDE AND OVERHEAD SUPPORT SYSTEM

Optional hydraulic side or overhead supports help prevent distortion of the cylinder in large shaped bends. Side supports have hydraulic double cylinders which are produced with heavy-duty steel construction. The vertical support capacity can be manufactured to different tonnage and height requirements.



CUSTOM PLATE SUPPORT SYSTEMS



Cartesian type overhead support

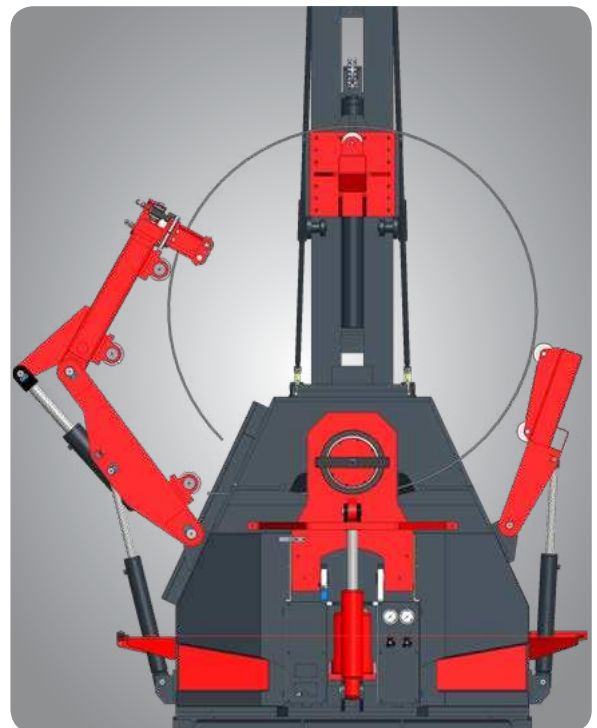

Dual knuckle side support with edge alignment clamps

OPTIONAL QUICK CHANGEABLE TOP ROLL

Sometimes the diameter of the parts to be bent may be smaller than the standard upper roller. In this case the interchangeable upper roller with a smaller diameter can be easily replaced with the standard upper roller, which increases the versatility of the machine. Custom crowning or custom shaped upper rolls can also be easily attached to our plate rolls to accommodate specific applications.



OPTIONAL AUTOMATIC LUBRICATION SYSTEM

In our roll bending machines, rollers are turn on roller bearings and bronze bushings. A machine with standard features has 10 lubrication points and must be lubricated with grease at regular intervals. However, sometimes machine operators may forget to lubricate, which can cause serious problems at all running points. Automatic lubrication system is a complete solution to avoid such a problem. In addition to air-powered models, we also have motorized lubrication solutions. NC and CNC control units can be programmed in desired time intervals and desired quantity as long as they operate the machine.

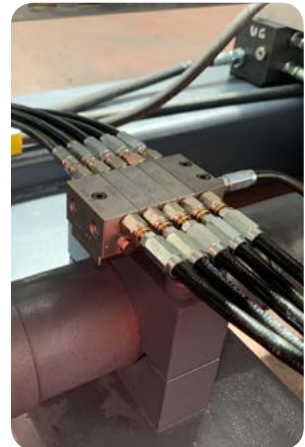

OPTIONAL GAS SHOCK ABSORBER

When the plates are bent, welding process begins on the machine. In particular, the combination of tension that occurs during welding of thin plates point inward pulling thus causes the deterioration of cylindrical form. So, expressed as re-rolling must be done after the welding operation in calibration. However, often the welding would be thicker than the plate thickness and shall not be cleaned. On standard machines welding cannot pass through between top and bottom rolls if plate is pinched. If clamping pressure too much and welding area too thick, rolls have chances of getting damaging dents to roll surface. Anerka has developed gas shock absorber to eliminate this problem. Each end of the lower roller system on the hydraulic accumulators we connected to the hydraulic cylinders and lower roll when the desired deflection controlling valves consists of. Thus, when welding passing through the roller, lower roller moves up and down automatically.



OPTIONAL OIL COOLER & HEATER

In countries where the air temperature is high, the oil of the machines may increase depending on the working intensity. The viscosity of the warm oil decreases and viscosity to an increase in tolerances, particularly when positioning hydraulic cylinders specially NC or CNC controlled machines.

To prevent this, air oil coolers are used.

Again, the viscosity of the oil decreases in regions where the air temperature is cold. In this case, the heater is placed in the tank so that the oil reaches the proper temperature before the first start in the morning.



PLC CONTROL SYSTEM (STANDARD)

The PLC Electronic balancing system ensures the synchronous operation of the bottom and side rollers of the HR-3, HR-4, HRR-4 series machines. This process is provided by PLC and touch operator panel which controls 6 axes. In addition, ease of use and time saving are provided by the ability to program up to 5 set points of the previously experienced bending values.



PLC Control Unit



- Dedicated scratch-proof, oil-proof, acid-resistant IP65 sealed touch panel
- PLC
- Panasonic 32 I/O
- Memory
- 5 Mbyte
- Display
- Monochrome LCD 3" touch screen
- Resolution
- 128 (W) x 64 (H)
- 3 colors led backlight (green,red, orange)
- Communication port 1 RS232C Serial Port
- Temperature -20 / 60°C

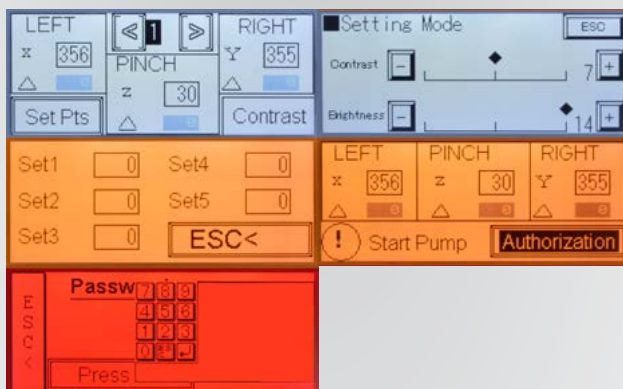

Software

- Manual working mod,
- Standard 6 axes (X1,X2,Y1,Y2,P,P1),
- 3 colors display for machine situation
- Conic and parallelism control
- 5 set point programing,
- Contrast adjusting ,
- Turkish,English, German, French, Spanish, Polish, Hungarian, Croation languages.
- Alarm list.

OPTIONAL NC (SIMPLE CNC)



NC control system, in addition to the PLC control system, has the property to work manual, teach-in and automatic modes of operation. In manual mode, the use of all functions are provided by the operator. In teaching mode for the operator to twist all the steps are recorded respectively. In automatic mode all recorded movements are repeated, respectively by the machine.

Thanks to the software we developed, the NC unit also calculates the theoretical bending steps one by one. The operator can achieve perfect bend only by changing the pre-bend and rolling values that calculated by the software. NC control system has the capacity to save 2500 programs consisting of Max 100-steps.

1- Manual Mode

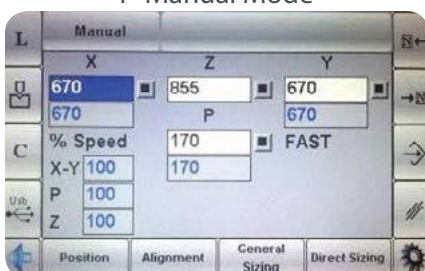

2- Teach-In Programming



3- Select material, enter thickness





NC Control Unit (S530)

Dedicated scratch-proof, oil-proof, acid-resistant IP65 sealed membrane push buttons with 51 keys
Fiberoptic communication lines.

PLC
Esa/Gv

CPU
AMD Geode™ LX800 500MHz

Memory
256 Mbyte DRAM for CPU
1 Mbyte SRAM for parameters

Display
Color TFT-LCD 7" WVGA (16:9)
Resolution (800 x 480, (R.G.B)) 262,144 colors

Communication ports 1 Ethernet Port
1 CAN interface
1 RS232C Serial Port
2 USB Port, 1 VGA Out

Temperature -25 / 70°C

Software
Manual, teach-in and automatic working modes,
Standard 7 axes (X1,X2,Y1,Y2,P1,P2,Z),
Conic and parallelism control
Dual speed,
100 step, 2500 program memory,
User friendly program editor,
USB port for programs backup ,
Parts quantity programming,
Working hours counter,
Metric and imperial units,
Automatic turn off programming,
Turkish, English, German, French, Spanish, Italian,
Russian, Polish, languages.
Alarm list.



4- Enter radius and arc angle / length

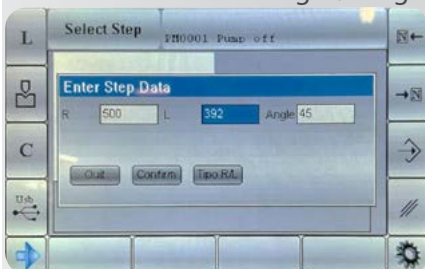

5- Program Calculated by NC



6- Saved programs

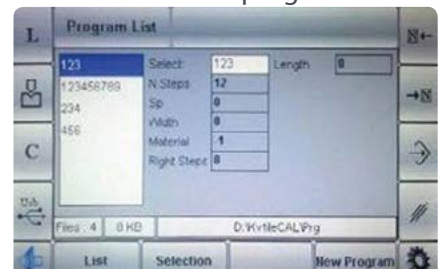

OPTIONAL CNC



The CNC unit, with its graphical control system allows the bending to be done step by step or by automatically calculating the bending steps. Due to changes in the structure of the material, corrections must be entered for pre-bending and bending steps after the first bended plate to get the desired bending form. Correction coefficients can be recorded to software for using them in similar characteristic material bending operations. With the CNC control you can easily bend parts into shapes such as: cylindrical, polycentric, elliptical, oval, parallel side, rectangular, and arc. CNC unit has interpolation capability due to proportional valves. The CNC unit can store more than 2,000,000 programs. The easy to use editor page also allows for simple editing of any saved programs. The unit also comes with a USB port allowing for easy up or downloading of your programs. You can also connect the control directly with your computer using an Ethernet cable. This also allows our service team to remote in if diagnosis is ever necessary. This also allows our service team to remotely access the machine if diagnosis is ever necessary. Lubrication system (offered as an option) operating times can be set at the control unit. Plate feeder, vertical and side supports (offered as an option) can be included as NC functions (teachable) into control unit. So supports can be programmed in teach-in mode and provided automatically during bending.

1- Manual Mode

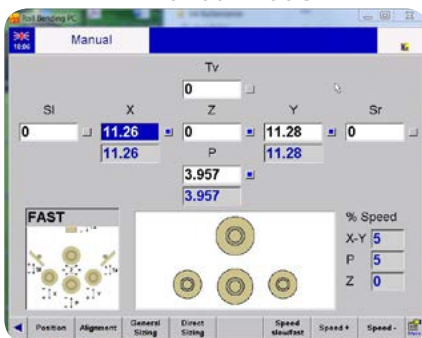

2- Select shape

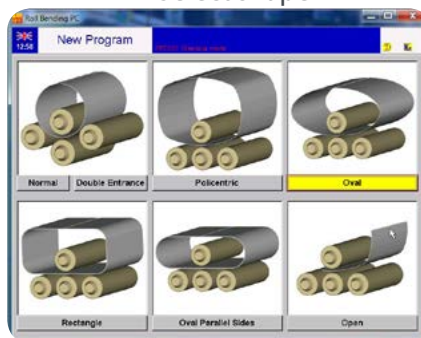

3- Select material, enter thickness

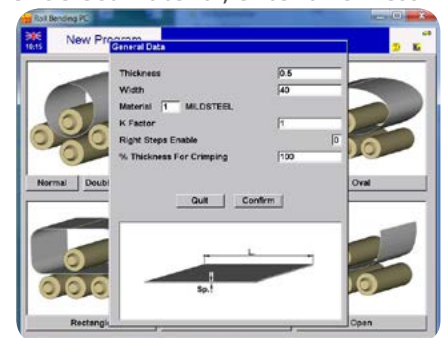

4- Enter part dimensions

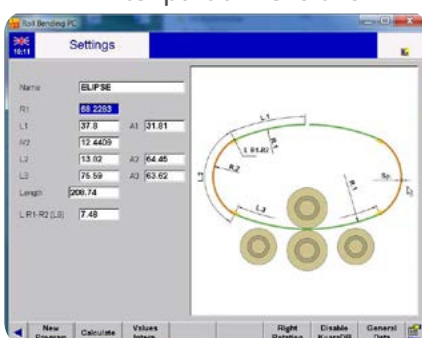

5- Program Calculated by CNC



6- Start bending



CNC Unit (S550 PC)

- Standard 7 axes (X1,X2,Y1,Y2,P1,P2,Z)
- Standard 32 inputs and 32 outputs
- 15" TFT XGA color touch display with antiglare screen
- Dedicated scratchproof, oil-proof IP65 keyboard with 28 keys
- 2.5" Hard disk drive 20GBytes or more
- Hand wheel for adjustable turning speed
- Industrial keyboard (USB)

Technology:

- CPU PC: Intel Atom N270 1,6Ghz with 1Gb of RAM
- CPU CNC: AMD Geode ETX-LX800 500 Mhz, with 128Mb

Communication ports:

- 1 serial ports RS-232, 3 USB ports,
- 2 Ethernet port on the PC
- 2 serial ports RS-232, 2 USB, 1 Ethernet port,
- 1 Can Open Port on CNC
- Fiber optic interface
- Local area network

User memory:

- Hard disk for more than 2.000.000 programs,

Software specifications:

- Windows® 10 operating system
- Manual, teach-in and automatic working modes,
- Conic and parallelism control,
- Interactive 2D graphic editor for work-pieces and tools data entry ,
- 2D graphic display of machine rolls,
- 2D automatic identification of the best bending sequence ,
- Programming of the axes positions in tabular mode with automatic syntactical checks,
- Automatic calculation of the X,R,P and Z axes positions for cylindrical, polycentric, oval, oval parallel sides, rectangular, arc bending shapes,
- Material database of common steel plates,
- X-Z / Y-Z (Side Roll & Rotation) axes interpolation capability
- Parts quantity programing, Working hours counter,
- Metric and imperial units,
- Offline programming
- Turkish, English, German, French, Spanish, Italian, Russian, Polish, languages.
- Alarm messages



Offline software for Windows



7- Make corrections

8- Insert corrections to database

9- Saved programs

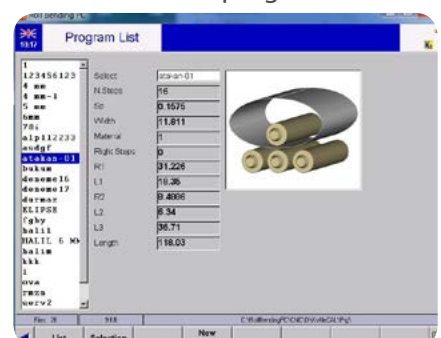
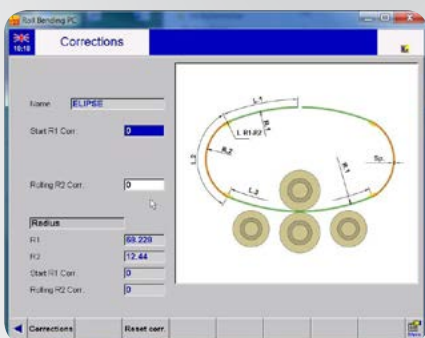

HR-4

HYDRAULIC PLANETARY TYPE FOUR ROLL BENDING MACHINE



HR-4 - Planetary gearboxes



Light and Mid Plates, High Volume

HR-4 machines have robust frames built with high quality steel construction and are fully hydraulic. Top and bottom roll are powered by hydraulic motor and planetary gearbox. This is an ideal machine for shops that need an easy machine to operate using a 4 roll design, and working with material ranging from 2mm to 44mm. These machines come standard with conical bending for making cone shaped parts and hydraulic bottom and side roll adjustments. The HR-4 machine is available from 1,2m-4m lengths making it very flexible for a wide range of applications, so you get the right machine for your needs... Not a one size fits all approach.



OPTIONAL CONICAL ROLLS



OPTIONAL PLASTIC / METAL COLLARS

We can build a machine to suit your particular requirements - (Collars can be a nice option if you are planning on forming composite panels & column covers with inside/up flange)

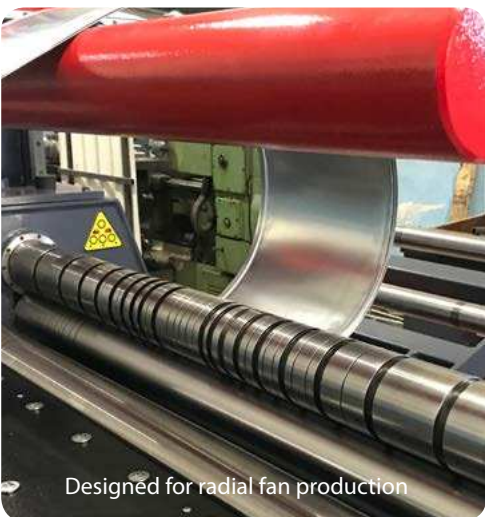
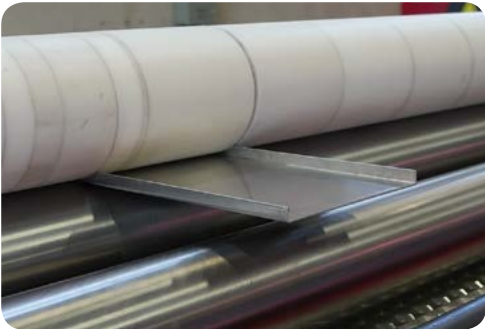
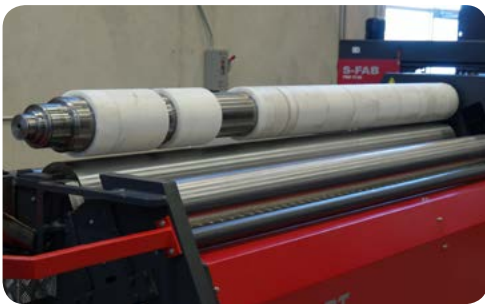

HR-4

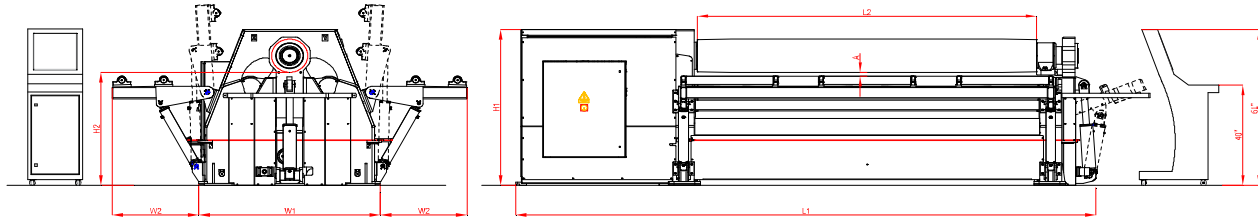

TYPE	Bending Length L2 (mm)	Min. Int. Dia Ø Dmin			Top Roll Ød (mm)	Bottom Roll Ø (mm)	Side Rolls Ø (mm)	Max. Pass Through A (mm)	Lenght L1 (mm)	Width W (mm)	Height H1 (mm)	Working Height H2 (mm)	Width of Side Support W2 (mm)	Weight (kg)	Motor Power (kW)	Min. Additional top roll diameter Ø (mm)	Hydraulic Tank Capacity (lt)
		Pre-Bending Capacities Ødx1,5 t (mm)	Bending Capacities Ødx3 T (mm)	Bending Capacities Ødx5 T (mm)													
HR-4 1280-140	1280	4	5	6	140	140	130	12	3100	970	1140	880	550	2430	4	140	90
HR-4 1280-150	1280	5	7	8	150	150	130	12	3100	970	1140	875	550	2490	5.5	140	90
HR-4 1280-170	1280	6	8	9	170	170	140	15	3100	970	1140	865	550	2660	5.5	140	90
HR-4 1550-140	1550	3	4	5	140	140	130	12	3100	970	1140	880	550	2430	4	140	90
HR-4 1550-150	1550	4	5	6	150	150	130	12	3100	970	1140	875	550	2490	5.5	140	90
HR-4 1550-170	1550	5	7	8	170	170	140	15	3100	970	1140	865	550	2660	5.5	140	90
HR-4 2050-140	2050	2	3	4	140	140	130	12	3600	970	1140	880	550	2600	3	140	90
HR-4 2050-150	2050	3	4	5	150	150	130	12	3600	970	1140	875	550	2690	4	140	90
HR-4 2050-170	2050	4	6	7	170	170	140	15	3600	970	1140	865	550	2920	5.5	140	90
HR-4 2050-200	2050	6	8	10	200	200	190	30	3830	1160	1180	840	665	4340	7.5	200	160
HR-4 2050-210	2050	8	10	12	210	190	180	30	3830	1160	1180	835	665	4250	11	200	160
HR-4 2050-230	2050	10	13	15	230	210	190	30	3830	1160	1180	825	665	4570	11	200	160
HR-4 2050-270	2050	13	16	18	270	250	220	50	4260	1660	1590	1155	800	8000	15	270	400
HR-4 2050-300	2050	16	20	22	300	270	220	50	4260	1660	1590	1140	800	8500	18.5	270	400
HR-4 2050-330	2050	20	25	28	330	300	240	50	4260	1660	1590	1125	800	9200	22	270	400
HR-4 2050-360	2050	25	30	33	360	330	270	60	4510	2060	2050	1510	1060	13950	30	360	600
HR-4 2050-400	2050	30	35	38	400	370	290	65	4510	2060	2050	1490	1060	15300	37	360	600
HR-4 2050-430	2050	35	40	44	430	400	320	70	4510	2060	2050	1475	1060	16380	45	360	600
HR-4 2550-200	2550	4	6	7	200	200	190	30	4330	1160	1180	840	665	4970	7.5	200	160
HR-4 2550-210	2550	6	8	10	210	190	180	30	4330	1160	1180	835	665	4850	11	200	160
HR-4 2550-230	2550	8	10	12	230	210	190	30	4330	1160	1180	825	665	5250	11	200	160
HR-4 2550-270	2550	10	13	15	270	250	220	50	4760	1660	1590	1155	800	8840	15	270	400
HR-4 2550-300	2550	13	16	18	300	270	220	50	4760	1660	1590	1140	800	9600	18.5	270	400
HR-4 2550-330	2550	16	20	22	330	300	240	50	4760	1660	1590	1125	800	10500	22	270	400
HR-4 2550-360	2550	20	25	28	360	330	270	60	5010	2060	2050	1510	1060	15150	22	360	600
HR-4 2550-400	2550	25	30	33	400	370	290	65	5010	2060	2050	1490	1060	16420	30	360	600
HR-4 2550-430	2550	30	35	38	430	400	320	70	5010	2060	2050	1475	1060	17750	37	360	600
HR-4 3100-210	3100	4	6	7	210	190	180	30	4880	1160	1180	835	665	5200	7.5	200	160
HR-4 3100-230	3100	6	8	10	230	210	190	30	4880	1160	1180	825	665	5800	11	200	160
HR-4 3100-270	3100	8	10	12	270	250	220	50	5310	1660	1590	1155	800	9700	11	270	400
HR-4 3100-300	3100	10	13	15	300	270	220	50	5310	1660	1590	1140	800	10600	15	270	400
HR-4 3100-330	3100	13	16	18	330	300	240	50	5310	1660	1590	1125	800	11600	18.5	270	400
HR-4 3100-360	3100	16	20	22	360	330	270	60	5560	2060	2050	1510	1060	16650	22	360	600
HR-4 3100-400	3100	20	25	28	400	370	290	65	5560	2060	2050	1490	1060	18300	30	360	600
HR-4 3100-430	3100	25	30	33	430	400	320	70	5560	2060	2050	1475	1060	20500	37	360	600
HR-4 4100-245	4100	3	5	5.5	245	230	190	15	5700	1170	1312	1003	665	8300	11	200	160
HR-4 4100-270	4100	4	6	7	270	250	220	50	6310	1660	1590	1155	800	11400	11	270	400
HR-4 4100-300	4100	6	8	10	300	270	220	50	6310	1660	1590	1140	800	12700	15	270	400
HR-4 4100-330	4100	8	10	12	330	300	240	50	6310	1660	1590	1125	800	14100	15	270	400
HR-4 4100-360	4100	10	13	15	360	330	270	60	6560	2060	2050	1510	1060	19350	18.5	360	600
HR-4 4100-400	4100	13	16	18	400	370	290	65	6560	2060	2050	1490	1060	21300	22	360	600
HR-4 4100-430	4100	16	20	22	430	400	340	70	6560	2060	2050	1475	1060	23810	30	360	600

The mentioned values above is only works for 260 N/mm²
 Different material and widths ; can be calculated with ANERKA Roll Bending Calculator
 Conic bending capacities depends on the angle and half value of mentioned values above
 Weight and motor powers may increase with optional features.
 Due to ongoing product development, specifications may change at any time

**Larger or Custom
Machines Available**

HR-4

STANDARD

- Planetary type side roll movement.
- PLC Electronic balancing system
- Cone bending
- Induction hardened rolls (HRc 56±4)
- Polished rolls
- Single speed control of all axis
- Dual speed control of all axis (NC machines)
- Variable speed control of all axis (CNC machines)
- Machine body constructed of stress-relieved
- Highly durable carbon steel rolls machined by CNC Lathes with optimal crown (special crown upon request)
- Rolls seated in spherical bearings and bronze bushings
- Hydraulic bracket (drop end) with easy pull out system
- Top and bottom rolls driven with hydraulic motor and planetary gear box
- Automatic rolls peripheral speed compensation (optimum distribution of torque)
- Adjustable hydraulic pressure on bottom roll (crowning compensation)
- Emergency stop wire around the machine
- Electrical and hydraulic protection against overloads
- World standard electrical and hydraulic components
- Mobile control panel
- Manual lubrication
- Welding possibility on the machine

OPTIONAL

- NC Unit (Simple CNC)
- CNC Control Unit with color graphical control
- AISI 4140 High strength alloy steel rolls
- Four rolls drive
- Wired or wireless remote control
- Oil cooler
- Oil heater
- Side support system (both sides)
- Vertical hydraulic overhead support system 4, 6, 8 TON (3m - 4m - 5m - 6m diameters)
- Preparation for side or vertical support system
- NC inclusion for vertical support control (Available on CNC control)
- NC inclusion for side support control (Available on CNC control)
- Plate alignment unit
- Automation system
- Changeable top roll for smaller diameter
- Special roll crowning
- Special plate support systems
- Automatic central lubrication
- Material feeding table (Idle or motorized)

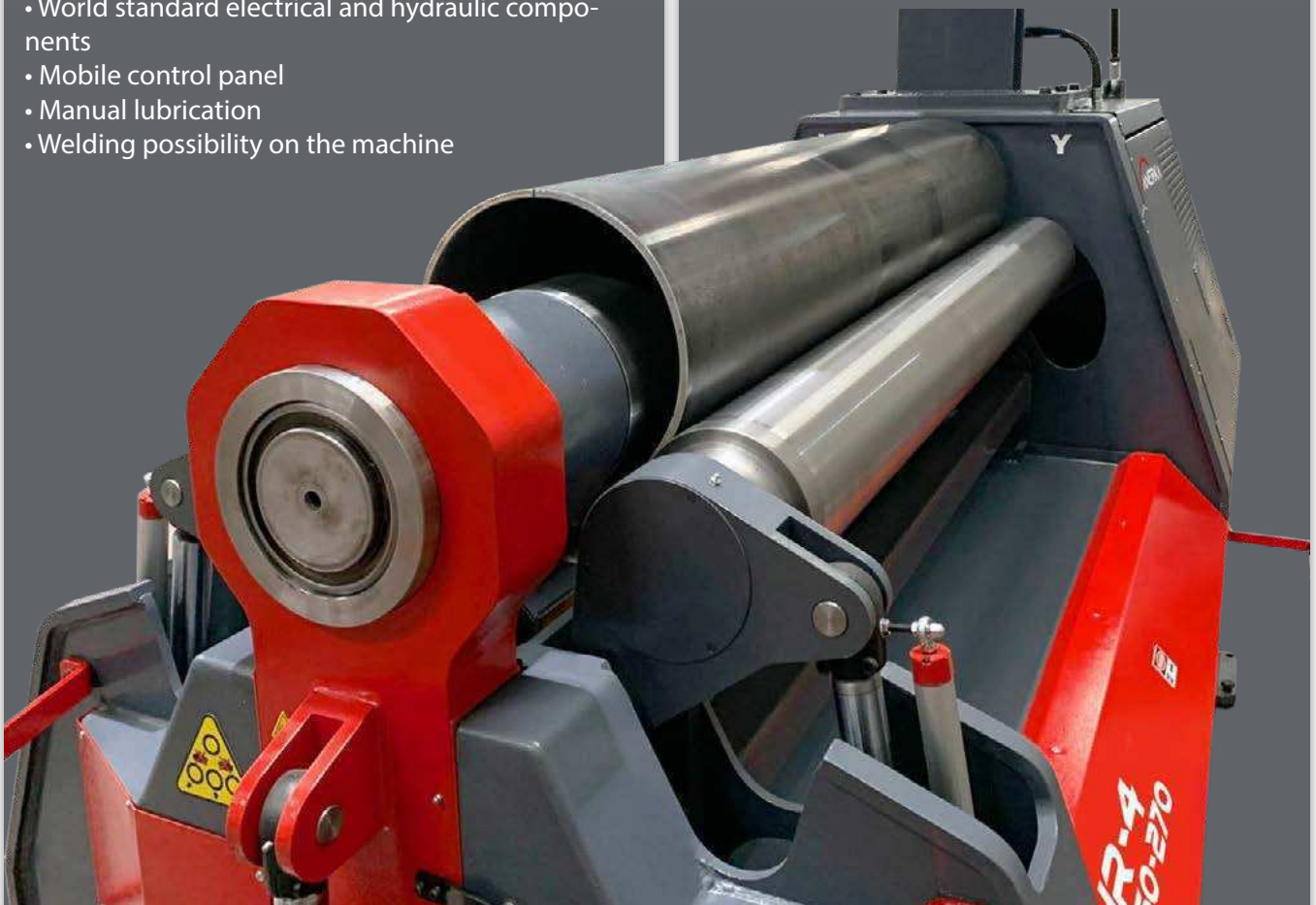

HRR-4

HYDRAULIC RECTILINEAR TYPE FOUR ROLL BENDING MACHINE



HRR-4 - Planetary gearboxes



Mid and Heavy Plates, High Volume

HRR-4 series designed for bending medium and thick plates in minutes. Side rolls positioned on both sides of the upper and lower roller and moves on linear line and able to bend very end of plate edge. All rollers are mounted with double row roller bearings. In this way, the generated torque allows the bending process to be performed in fewer steps without any loss. Thanks to the fully symmetrical upper roller bearing system, no diameter difference occurs during bending and is completed in a much shorter time.



HRR-4



With the optional automatic central lubrication, the rollers and bearings operate with the same precision for many years.

Hydraulic drop ends on HRR-4 Plate Rolls allow for easy removal of formed pieces. Also the top roll is hydraulically tilted up to allow for easy removal of formed parts.



HRR-4

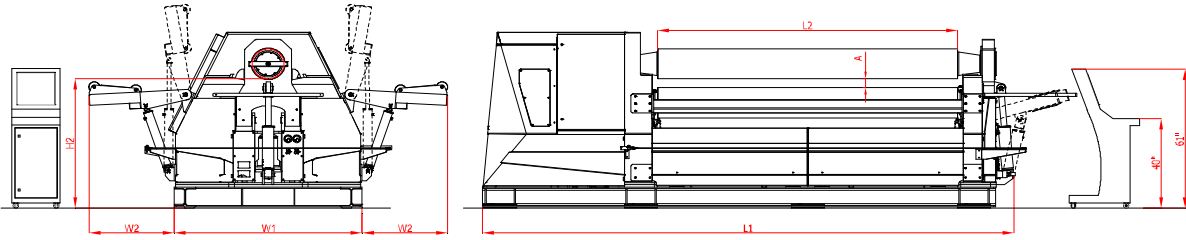

TYPE	Bending Length L2 (mm)	Min. Int. Dia Ø Dmin			Top Roll Ød (mm)	Bottom Roll Ø (mm)	Side Rolls Ø (mm)	Max. Pass Through A (mm)	Length L1 (mm)	Width W (mm)	Height H1 (mm)	Working Height H2 (mm)	Width of Side Support W2 (mm)	Weight (kg)	Motor Power (kW)	Min. Additional top roll diameter Ø (mm)	Hydraulic Tank Capacity (lt)
		Pre-Bending Capacities Ødx2	Bending Capacities Ødx4	Bending Capacities Ødx5													
		t (mm)	T (mm)	T (mm)													
HRR-4 2050-330	2050	20	25	28	330	300	240	50	4260	1660	1590	1125	885	9200	22	270	400
HRR-4 2050-360	2050	25	30	33	360	330	270	60	4510	2060	2050	1510	885	13950	30	360	600
HRR-4 2050-400	2050	30	35	38	400	370	290	65	4510	2060	2050	1490	1150	15300	37	360	600
HRR-4 2050-430	2050	35	40	44	430	400	320	70	4510	2060	2050	1475	1150	16380	45	360	600
HRR-4 2050-460	2050	40	50	55	460	440	360	105	4634	2280	2375	1767	1360	23800	45+22	430	830
HRR-4 2050-480	2050	50	65	70	480	455	370	90	4634	2280	2375	1757	1360	24800	55+22	430	830
HRR-4 2550-330	2550	16	20	22	330	300	240	50	4760	1660	1590	1125	885	10500	22	270	400
HRR-4 2550-360	2550	20	25	28	360	330	270	60	5010	2060	2050	1510	885	15150	22	360	600
HRR-4 2550-400	2550	25	30	33	400	370	290	65	5010	2060	2050	1490	1150	16420	30	360	600
HRR-4 2550-430	2550	30	35	38	430	400	320	70	5010	2060	2050	1475	1150	17750	37	360	600
HRR-4 2550-460	2550	35	40	44	460	440	360	105	5134	2280	2375	1767	1360	26400	37+22	430	830
HRR-4 2550-480	2550	40	50	55	480	455	370	90	5134	2280	2375	1757	1360	32200	45+22	430	830
HRR-4 2550-540	2550	45	60	63	540	520	420	145	5535	2630	2787	2035	1565	42500	37+37	500	1100
HRR-4 3100-330	3100	13	16	18	330	300	240	50	5310	1660	1590	1125	885	11600	18.5	270	400
HRR-4 3100-360	3100	16	20	22	360	330	270	60	5560	2060	2050	1510	885	16650	22	360	600
HRR-4 3100-400	3100	20	25	28	400	370	290	65	5560	2060	2050	1490	1150	18300	30	360	600
HRR-4 3100-430	3100	25	30	33	430	400	320	70	5560	2060	2050	1475	1150	20500	37	360	600
HRR-4 3100-460	3100	30	35	38	460	440	360	105	5684	2280	2375	1767	1360	31500	37+22	430	830
HRR-4 3100-480	3100	35	40	44	480	455	370	90	5684	2280	2375	1757	1360	35000	45+22	430	830
HRR-4 3100-520	3100	40	50	53	520	500	410	165	6085	2630	2787	2045	1565	45000	30+30	500	1100
HRR-4 3100-580	3100	45	60	63	580	560	440	105	6085	2630	2787	2015	1565	50000	37+37	500	1100
HRR-4 3100-650	3100	50	70	74	650	610	500	150	6370	3240	3660	2825	1800	72000	45+45	630	1700
HRR-4 3100-760	3100	70	90	95	760	720	600	190	7100	3800	4290	3333	1800	110000	55+55	730	2200
HRR-4 4100-330	4100	8	10	12	330	300	240	50	6310	1660	1590	1125	885	14100	15	270	400
HRR-4 4100-360	4100	10	13	15	360	330	270	60	6560	2060	2050	1510	885	19350	18.5	360	600
HRR-4 4100-400	4100	13	16	18	400	370	290	65	6560	2060	2050	1490	1150	21300	22	360	600
HRR-4 4100-430	4100	16	20	22	430	400	340	70	6560	2060	2050	1475	1150	23810	30	360	600
HRR-4 4100-460	4100	20	25	28	460	440	360	90	7200	2300	2530	1875	1360	39000	37	430	830
HRR-4 4100-480	4100	24	30	33	480	455	370	90	6684	2280	2375	1757	1360	43000	37+22	430	830
HRR-4 4100-520	4100	28	35	39	520	500	410	165	7085	2630	2787	2045	1565	50000	30+30	500	1100

The mentioned values above is only works for 260 N/mm²
 Different material and widths ; can be calculated with ANERKA Roll Bending Calculator
 Conic bending capacities depends on the angle and half value of mentioned values above
 Weight and motor powers may increase with optional features.
 Due to ongoing product development, specifications may change at any time

**Larger or Custom
Machines Available**

Double knuckle side support with lip aligner



HRR-4

STANDARD

- Rectilinear type side roll movement.
- PLC Electronic Balancing System
- Cone bending
- Induction hardened rolls (HRC 54-58)
- Polished rolls
- Single speed control of all axis
- Dual speed control of all axis (NC machines)
- Variable speed control of all axis (CNC machines)
- AISI 1050 Carbon steel rolls machined by CNC Lathes with optimal crown (special crown upon request)
- Automatic rolls peripheral speed compensation (optimum distribution of torque)
- Machine body constructed of stress-relieved high-yield steel
- Rolls seated in dual spherical bearings
- Hydraulic titable top roll and bracket (drop end) with easy pull out system
- Top and bottom rolls driven with hydraulic motor and planetary gear box
- Emergency stop wire around the machine
- Electrical and hydraulic protection against overloads
- World standard electrical and hydraulic components (parts stocked by ANERKA or available off-the-shelf from your local supplier)
- Adjustable hydraulic pressure on bottom roll (crowning compensation)
- Mobile control panel
- Manual lubrication
- Welding possibility on the machine

OPTIONAL

- NC Unit (Simple CNC)
- CNC Control Unit with color graphical control
- AISI 4140 High strength alloy steel rolls
- Four rolls drive
- Wired or wireless remote control
- Oil cooler
- Oil heater
- Side support system (both sides)
- Vertical hydraulic overhead support system 6, 8, 15 TON (3m - 4m - 5m - 6m diameters)
- Preparation for side or vertical support system
- NC inclusion for vertical support control (Available on CNC control)
- NC inclusion for side support control (Available on CNC control)
- Plate alignment unit
- Automation system
- Changeable top roll for smaller diameter
- Special roll crowning
- Special plate support systems
- Automatic central lubrication
- Material feeding table (Idle or motorized)
- Separated power cabin



HR-3

HYDRAULIC PLANETARY TYPE THREE ROLL BENDING MACHINE

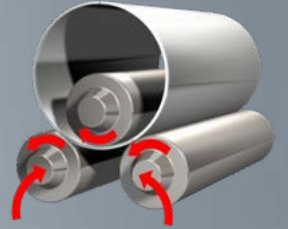

HR-3 - Planetary gearboxes



Versatile, Mid Plates, Job Shops

HR-3 series hydraulic 3 roll plate bending machines usually ideal for obtaining large diameters. Large diameter cylindrical bends used in silos, oil and water tanks, feed and grain bins can be made easily on these machines. The symmetrical 3-roll arrangement allows pre-bending to both ends of the plate if required. Although the bending process is slower than that of 4 roll machines, all kinds of profiles can be bend on these machines as well as plates due to the greater pass through.



HR-3

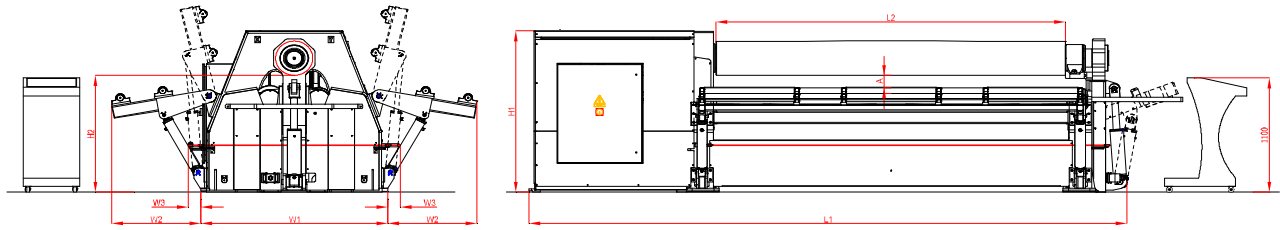

TYPE	Bending Length L2 (mm)	Min. Int. Dia Ø Dmin			Top Roll Ød (mm)	Side Rolls Ø (mm)	Max. Pass Through A (mm)	Length L1 (mm)	Width W (mm)	Height H1 (mm)	Working Height H2 (mm)	Width of Side Support W2 (mm)	Weight (kg)	Motor Power (kW)	Min. Additional top roll diameter Ø (mm)	Hydraulic Tank Capacity (lt)
		Pre-Bending Capacities t (mm)	Bending Capacities T (mm)	Bending Capacities T (mm)												
HR-3 2050-200	2050	6	8	10	200	180	90	3830	1160	1180	840	665	3420	7.5	200	160
HR-3 2050-210	2050	8	10	12	210	190	80	3830	1160	1180	835	665	3600	7.5	200	160
HR-3 2050-230	2050	10	13	15	230	200	70	3830	1160	1180	825	665	3800	11	200	160
HR-3 2050-270	2050	13	16	18	270	250	140	4260	1660	1590	1155	800	6850	15	270	400
HR-3 2050-300	2050	16	20	22	300	270	115	4260	1660	1590	1140	800	7300	18.5	270	400
HR-3 2050-330	2050	20	25	28	330	290	90	4260	1660	1590	1125	800	7930	22	270	400
HR-3 2050-360	2050	25	30	33	360	330	195	4510	2060	2050	1510	1060	12640	30	360	600
HR-3 2050-400	2050	30	35	38	400	350	165	4510	2060	2050	1490	1060	13400	37	360	600
HR-3 2050-430	2050	35	40	44	430	380	135	4510	2060	2050	1475	1060	14300	45	360	600
HR-3 2550-200	2550	4	6	7	200	180	90	4330	1160	1180	840	665	3800	7.5	200	160
HR-3 2550-210	2550	6	8	10	210	190	80	4330	1160	1180	835	665	4000	7.5	200	160
HR-3 2550-230	2550	8	10	12	230	200	70	4330	1160	1180	825	665	4350	11	200	160
HR-3 2550-270	2550	10	13	15	270	250	140	4760	1660	1590	1155	800	7550	15	270	400
HR-3 2550-300	2550	13	16	18	300	270	115	4760	1660	1590	1140	800	8200	18.5	270	400
HR-3 2550-330	2550	16	20	22	330	290	90	4760	1660	1590	1125	800	8900	22	270	400
HR-3 2550-360	2550	20	25	28	360	330	195	5010	2060	2050	1510	1060	12380	22	360	600
HR-3 2550-400	2550	25	30	33	400	350	165	5010	2060	2050	1490	1060	13300	30	360	600
HR-3 2550-430	2550	30	35	38	430	380	135	5010	2060	2050	1475	1060	14500	37	360	600
HR-3 3100-210	3100	4	6	7	210	190	80	4880	1160	1180	835	665	4500	7.5	200	160
HR-3 3100-230	3100	6	8	10	230	200	70	4880	1160	1180	825	665	4800	7.5	200	160
HR-3 3100-270	3100	8	10	12	270	250	140	5310	1660	1590	1155	800	8280	11	270	400
HR-3 3100-300	3100	10	13	15	300	270	115	5310	1660	1590	1140	800	9200	15	270	400
HR-3 3100-330	3100	13	16	18	330	290	90	5310	1660	1590	1125	800	9850	18.5	270	400
HR-3 3100-360	3100	16	20	22	360	330	195	5560	2060	2050	1510	1060	14900	22	360	600
HR-3 3100-400	3100	20	25	28	400	350	165	5560	2060	2050	1490	1060	16150	30	360	600
HR-3 3100-430	3100	25	30	33	430	380	135	5560	2060	2050	1475	1060	17700	37	360	600
HR-3 4100-270	4100	4	6	7	270	250	140	6310	1660	1590	1155	800	9710	11	270	400
HR-3 4100-300	4100	6	8	10	300	270	115	6310	1660	1590	1140	800	10600	11	270	400
HR-3 4100-330	4100	8	10	12	330	290	90	6310	1660	1590	1125	800	11780	15	270	400
HR-3 4100-360	4100	10	13	15	360	330	195	6560	2060	2050	1510	1060	17200	18.5	360	600
HR-3 4100-400	4100	13	16	18	400	350	165	6560	2060	2050	1490	1060	18900	22	360	600
HR-3 4100-430	4100	16	20	22	430	380	135	6560	2060	2050	1475	1060	21200	30	360	600

The mentioned values above is only works for 260 N/mm²
 Different material and widths ; can be calculated with ANERKA Roll Bending Calculator
 Conic bending capacities depends on the angle and half value of mentioned values above
 Weight and motor powers may increase with optional features.
 Due to ongoing product development, specifications may change at any time

**Larger or Custom
Machines Available**

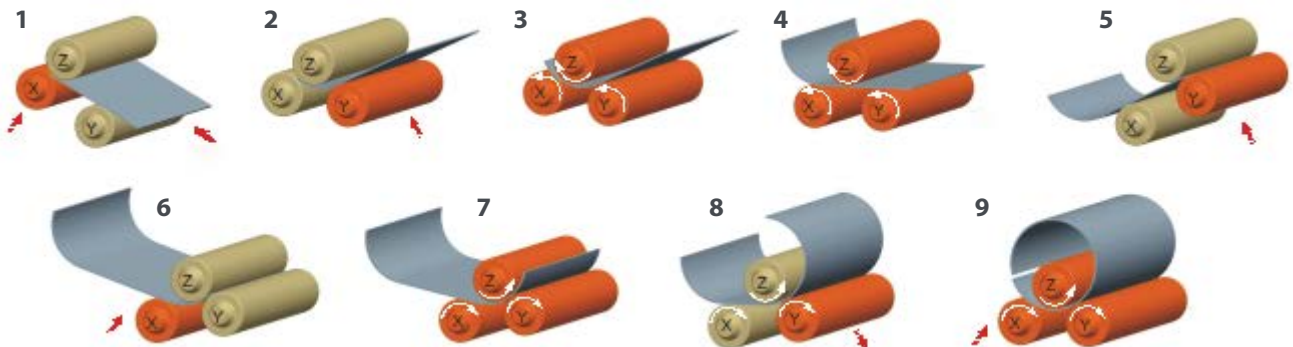

HR-3

STANDARD

- Planetary type side roll movement.
- PLC Electronic balancing system
- Cone bending
- Induction hardened rolls (HRc 56±4)
- Polished rolls
- Single speed control of all axis
- Machine body constructed of stress-relieved
- Highly durable carbon steel rolls machined by CNC Lathes with optimal crown (special crown upon request)
- Rolls seated in spherical bearings and bronze bushings
- Hydraulic bracket (drop end) with easy pull out system
- Top and side rolls driven with hydraulic motor and planetary gear box
- Automatic rolls peripheral speed compensation (optimum distribution of torque)
- Emergency stop wire around the machine
- Electrical and hydraulic protection against overloads
- World standard electrical and hydraulic components
- Mobile control panel
- Manual lubrication
- Welding possibility on the machine

OPTIONAL

- NC Unit (Teach and Play)
- AISI 4140 High strength alloy steel rolls
- Oil cooler
- Oil heater
- Side support system (both sides)
- Vertical hydraulic overhead support system 4, 6, 8 TON (10' - 14' - 16' - 20' tall)
- Preparation for side or vertical support system
- Plate alignment unit
- Changeable top roll for smaller diameter
- Special roll crowning
- Special plate support systems
- Automatic central lubrication
- Material feeding table (Idle or motorized)



VR-3

HYDRAULIC VARIABLE GEOMETRY THREE ROLL BENDING MACHINE



Mid and Heavy Plates, Rolling Shops

The variable-geometry plate rolls, which really operates more like a press brake than a traditional plate roll, makes not only extreme rolling possible, but much simpler. The two lower rolls are very similar to an adjustable V die, and the top roll can be operated like the ram of a press brake. That's why we called his machine VR-3. They are suitable for medium and thick plate bending.

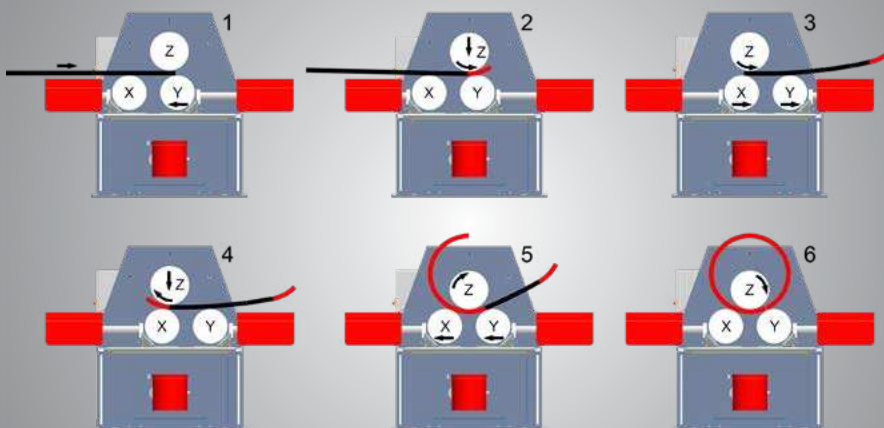

VR-3

PRE-BENDING ADVANTAGE

Position of the rolls for the pre-bending execution on the first edge of the plate. The right lateral roll supports the plate, while the left one works like a lower mould.

The top roll pushes directly on the first side of the plate deforming it according to the required radius. The top roll through its thrust force pushes the plate against the left lateral roll that, being displaced in respect to the top roll, allows the first side of the plate to get deformed. The bigger the top roll thrust is, the lower the flat-end and the plate bending radius are.

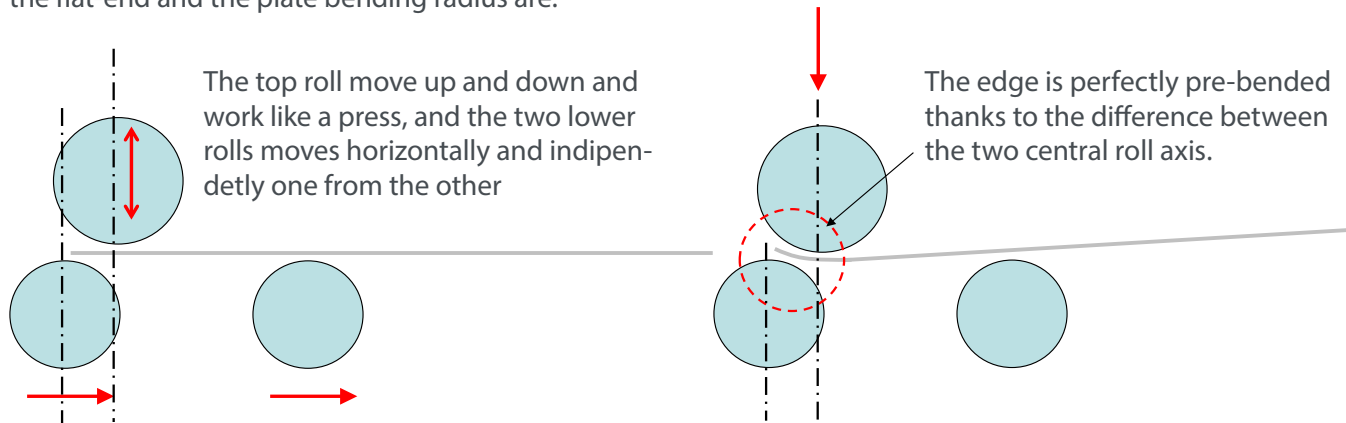

The pre-bending is performed by the top roll pushing directly against the first side of the plate, leaving a very short or null flat-end; the following rotation increases the curved initial side of the plate.

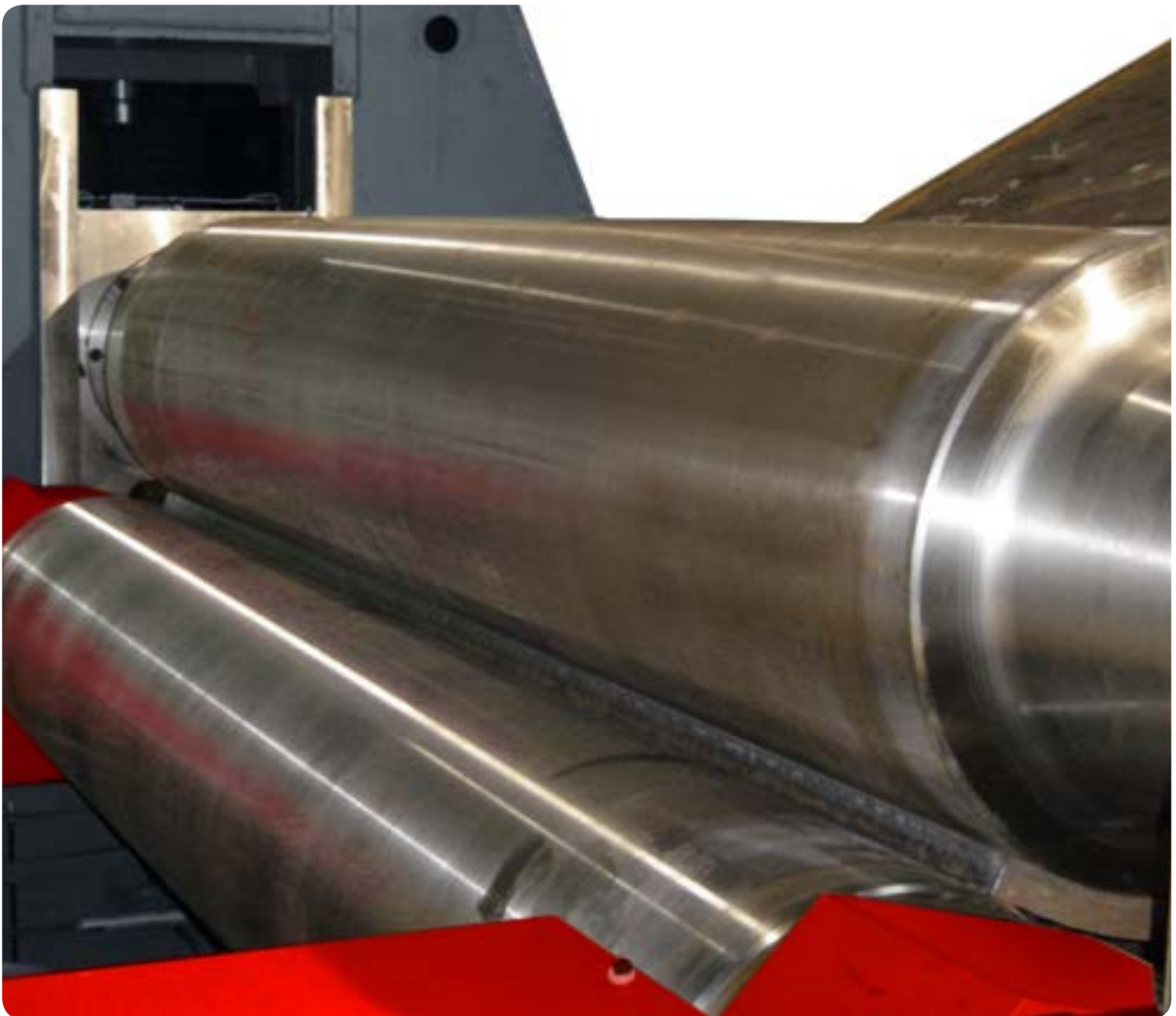

VR-3

CALIBRATION AFTER THE WELDING

Another important feature of the VR-3 plate roll, is the press like system of the top forming roll. In fact, the top forming roll can be used as a traditional press allowing perfect rerolling operation and calibration of thick plates. In the same way it is also possible to obtain cones with heavy thicknesses by bending the plate with several strokes.

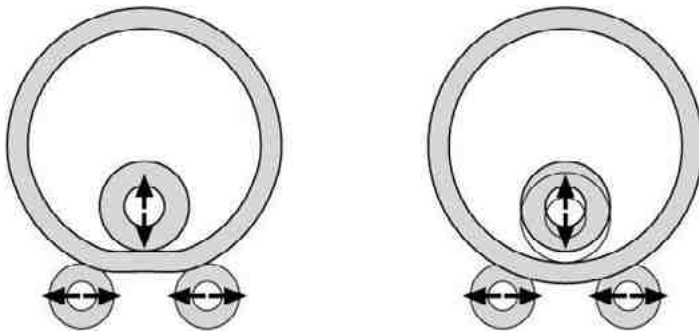

CONE BENDING

VR-3 plate rolls ability to tilt all 3 axis allow for the best and easiest production of conical shapes. Material blank also moves linear through the machine and not radial as on 4 rolls and traditional 3 rolls

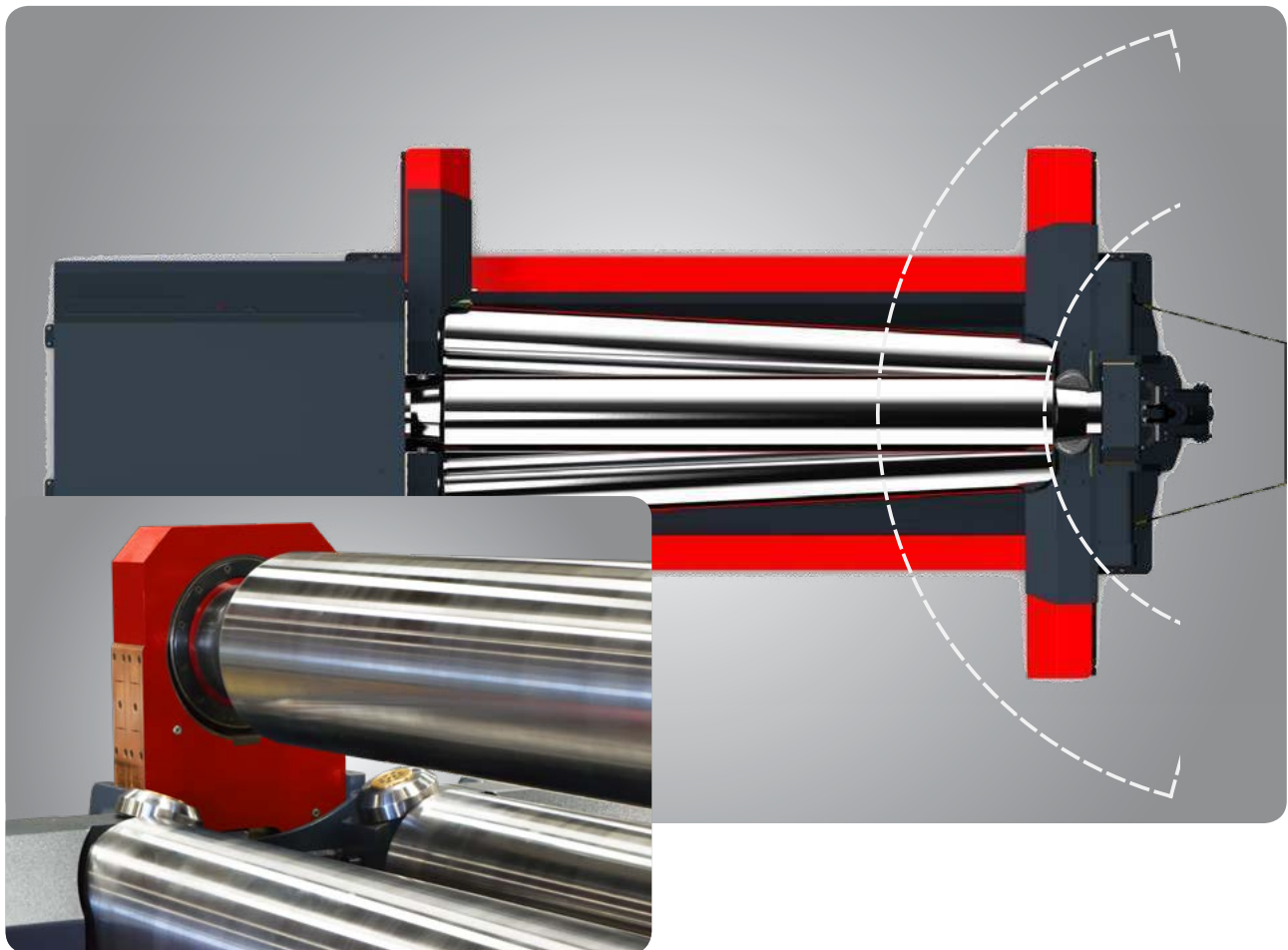

Dual cone bending bearings

VR-3

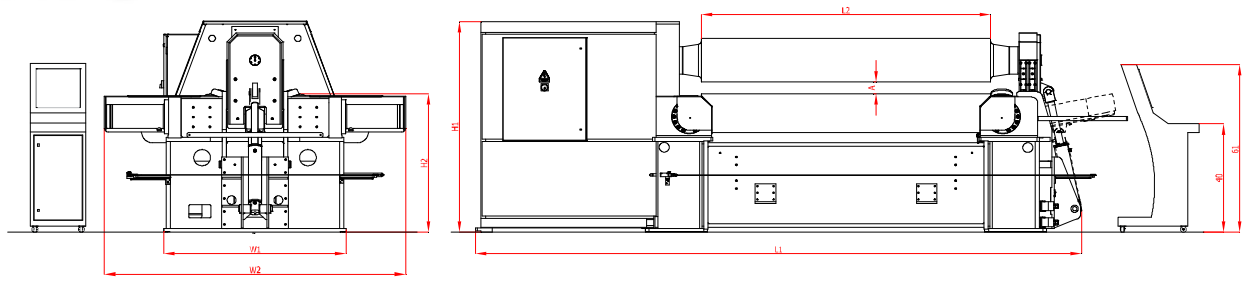

MODEL TYPE	Bending Length L2 (mm)	Min. Int. Dia Ø Dmin			Top Roll Ød (mm)	Lower Rolls Ø (mm)	Top Roll Bending Force Ton	Max. Pass Through A (mm)	Length L1 (mm)	Width W1 (mm)	Total Width W2 (mm)	Height H1 (mm)	Working Height H2 (mm)	Weight (Kg)	Main Motor (Kw)	Hydraulic Tank Capacity (l)
		Pre-Bending Capacities Ødx1,5 t (mm)	Pre-Bending Capacities Ødx5 t (mm)	Bending Capacities Ødx5 T (mm)												
VR-3 2550-350	2550	20	22	28	350	330	170	100	4880	1650	2700	1950	1250	16550	30	400
VR-3 2550-400	2550	25	30	40	400	360	210	100	5440	1650	2700	1950	1280	18500	37	400
VR-3 2550-450	2550	30	35	45	450	420	260	120	5600	1850	2900	2180	1440	23200	45	600
VR-3 2550-500	2550	35	40	52	500	460	320	135	5800	1980	3080	2400	1550	30500	55	750
VR-3 2550-560	2550	40	45	60	560	500	440	150	6050	2260	3530	2660	1760	42500	45+18.5	900
VR-3 3100-350	3100	16	20	25	350	330	160	100	5435	1650	2700	1950	1250	18000	30	400
VR-3 3100-400	3100	20	22	28	400	360	200	100	5950	1650	2700	1950	1280	20000	37	400
VR-3 3100-450	3100	25	30	40	450	420	260	120	6100	1850	2900	2180	1440	25000	45	600
VR-3 3100-500	3100	30	35	45	500	460	320	135	6300	1980	3080	2400	1550	33000	55	750
VR-3 3100-560	3100	35	40	52	560	500	440	150	6550	2260	3530	2660	1760	45000	45+18.5	900
VR-3 3100-620	3100	50	60	75	620	560	560	175	9000	2820	4400	1980	3000	65000	45+45	900
VR-3 3100-680	3100	60	70	85	680	600	800	200	9200	2900	4500	2030	3050	75000	55+55	900
VR-3 4100-350	4100	10	13	20	350	330	135	100	6650	1650	2700	1950	1250	21000	30	400
VR-3 4100-400	4100	13	16	25	400	360	160	100	6950	1650	2700	1950	1280	24000	37	400
VR-3 4100-450	4100	20	22	28	450	420	200	120	7100	1850	2900	2180	1440	27800	45	600
VR-3 4100-500	4100	25	30	40	500	460	260	135	7300	1980	3080	2400	1550	36500	55	750
VR-3 4100-560	4100	28	32	45	560	500	350	150	7550	2260	3530	2660	1760	48500	45+18.5	900

The mentioned values above is only works for 260 N/mm²
 Different material and widths ; can be calculated with ANERKA Roll Bending Calculator
 Conic bending capacities depends on the angle and half value of mentioned values above
 Weight and motor powers may increase with optional features.
 Due to ongoing product development, specifications may change at any time

Larger or Custom
Machines Available



VR-3 - Planetary gearbox

VR-3

STANDARD

- Variable geometry type rolls movement.
- PLC control unit
- Dual speed
- Cone bending with dual cone bending roller bearing
- Induction hardened rolls (HRC 54-58)
- AISI 1050 Carbon steel rolls machined by CNC Lathes with optimal crown (special crown upon request)
- Polished rolls
- Top and lower rolls electronically positioned and synchronized with PLC and high-end precision digital scales
- High stroke top roll
- Braking system on side rolls
- Protected slide surfaces
- Machine body constructed of stress-relieved high-yield steel
- Rolls seated in spherical bearings
- Top roll hydraulic opening device (drop end) with easy pull out system
- Top roll driven with hydraulic motor and planetary gear box
- Electrical and hydraulic protection against overloads
- World standard electrical and hydraulic components (parts stocked by ANERKA or available off-the-shelf from your local supplier)
- Adjustable hydraulic pressure on bottom roll (crowning compensation)
- Mobile control panel
- Manual lubrication
- Welding possibility on the machine

OPTIONAL

- NC Control Unit
- All axis positioning with adjustable speed on NC machines
- AISI 4140 High strength alloy steel rolls
- Ground rolls
- Variable speed control
- Wired or wireless remote
- Oil cooler
- Oil heater
- Hydraulic side support system (both sides)
- Vertical overhead support system
- Preparation for vertical support system
- Material feeding table (Idle or motorized)
- Plate alignment unit
- Separated power cabin
- Changeable top roll for smaller Diameter
- Automatic central lubrications
- Automation system
- Special roll crowning
- Special applications for wind tower production

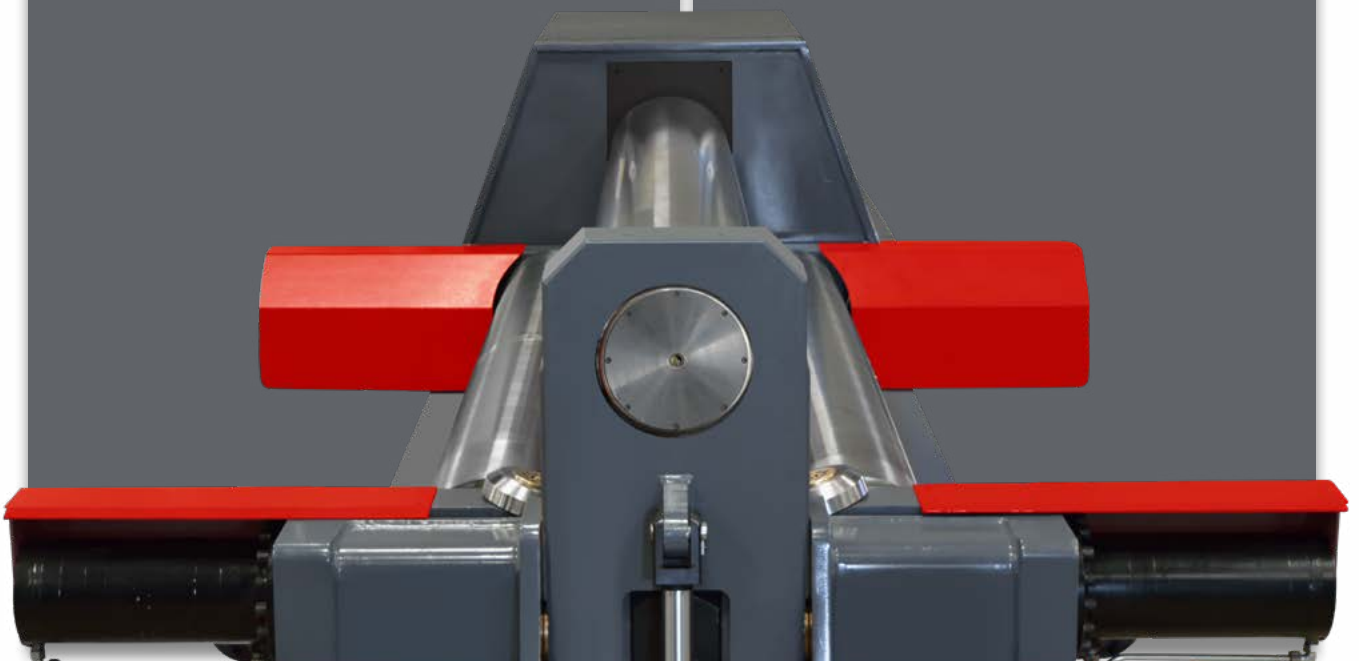

MRA / MRB

MOTORIZED INITIAL PINCH THREE ROLL BENDING MACHINE

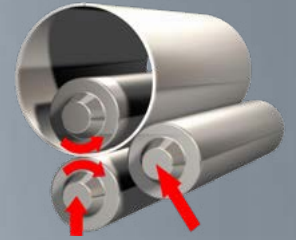

Light Sheets, Low Volumes

These initial pinch rolls are designed for small part bending with low operation cost. R-ECO rolls feature robust steel frames, chain and gearbox drive systems and electric motors with a magnetic break which eliminates drifting. They also offer foot pedals with forward, reverse, and emergency stop along with a safety wire and limit switch.

A very economical, reliable, and efficient choice for your small parts needs.



MRC / MRD

MOTORIZED INITIAL PINCH THREE ROLL BENDING MACHINE



MRC

Our MR series initial pinch plate rolls are usually for lighter capacity applications and come in manual or motorized. They work by “pinching” the flat sheet between top and bottom rolls while the side (back) roll moves upward to contact and then bend the sheet. When rotation of the rollers is activated, the sheet exits at a given radius. With the sheet cut to the developed length and the bending roll properly positioned; the part is rolled into a cylindrical form, where it can then be welded at the seam to produce a cylinder. The top roll is in a fixed position; the bottom pinch roll can move up/down to pinch the material. The side roll is also adjustable by manually or motorized. To remove a rolled cylinder, it must be extracted from off of the top roll. Machines are equipped with release mechanism on the top roll to allow extraction of the cylinder. Typical methods is releasing top roll or a removable end yoke. In most applications, these machines require removal and re-insertion of the sheet in order to pre-bend both ends. They are cost effective but in contrast may be more labor intensive in a production setting.



MRD

MRA Series



ø68-ø75mm

MRB Series



ø90-ø100mm

MRC Series



ø110-ø140mm

MRD Series



ø150-ø180mm

MRA-MRB

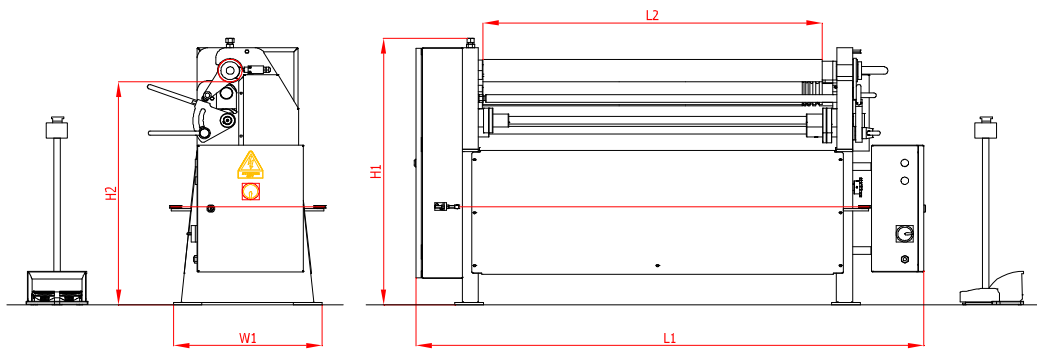

TYPE	Bending Length	Bending Capacity	Top Roll	Lenght	Width	Height	Working Height	Weight	Main Motor Power	Back Roll Motor Power (Optional)
	L2 (mm)	T (mm)	Ød (mm)	L1 (mm)	W (mm)	H1 (mm)	H2 (mm)	(kg)	(kW)	(kW)
MRA 1030-68	1030	1.5	68	1664	560	1052	880	380	0.75	0.37
MRA 1030-75	1030	2	75	1664	560	1052	880	385	0.75	0.37
MRB 1030-90	1030	2.5	90	1664	560	1052	880	450	1.5	0.55
MRB 1030-100	1030	3	100	1664	560	1052	880	485	1.5	0.55
MRA 1280-68	1280	1.2	68	1914	560	1052	880	445	0.75	0.37
MRA 1280-75	1280	1.5	75	1914	560	1052	880	455	0.75	0.37
MRB 1280-90	1280	2	90	1914	560	1052	880	530	1.5	0.55
MRB 1280-100	1280	2.5	100	1914	560	1052	880	575	1.5	0.55
MRA 1530-68	1530	0.8	68	2164	560	1052	880	500	0.75	0.37
MRA 1530-75	1530	1	75	2164	560	1052	880	530	0.75	0.37
MRB 1530-90	1530	1.5	90	2164	560	1052	880	600	1.5	0.55
MRB 1530-100	1530	2	100	2164	560	1052	880	660	1.5	0.55
MRA 2030-75	2030	0.5	75	2664	560	1052	880	585	0.75	0.37
MRB 2030-90	2030	1	90	2664	560	1052	880	680	1.5	0.55
MRB 2030-100	2030	1.5	100	2664	560	1052	880	750	1.5	0.55

The mentioned values above is only works for 260 N/mm²
 Different material and widths ; can be calculated with ANERKA Roll Bending Calculator
 Conic bending capacities depends on the angle and half value of mentioned values above
 Weight and motor powers may increase with optional features.
 Due to ongoing product development, specifications may change at any time

MRC

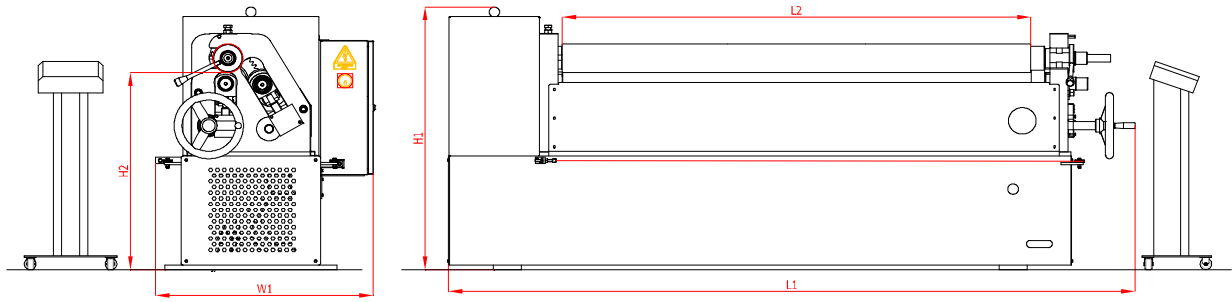

TYPE	Bending Length	Bending Capacity	Top Roll	Lenght	Width	Height	Working Height	Weight	Main Motor Power	Back Roll Motor Power (Optional)
	L2 (mm)	T (mm)								
MRC 1030-110	1030	4	110	1972	941	1191	895	1195	2.2	1.1
MRC 1030-120	1030	4.5	120	1972	941	1191	895	1235	2.2	1.1
MRC 1030-130	1030	5	130	1972	941	1191	895	1275	2.2	1.1
MRC 1030-140	1030	5.5	140	1972	941	1191	895	1315	2.2	1.1
MRC 1280-110	1280	3.5	110	2222	941	1191	895	1305	2.2	1.1
MRC 1280-120	1280	4	120	2222	941	1191	895	1345	2.2	1.1
MRC 1280-130	1280	4.5	130	2222	941	1191	895	1385	2.2	1.1
MRC 1280-140	1280	5	140	2222	941	1191	895	1425	2.2	1.1
MRC 1530-110	1530	2.5	110	2472	941	1191	895	1338	2.2	1.1
MRC 1530-120	1530	3	120	2472	941	1191	895	1378	2.2	1.1
MRC 1530-130	1530	3.5	130	2472	941	1191	895	1425	2.2	1.1
MRC 1530-140	1530	4	140	2472	941	1191	895	1472	2.2	1.1
MRC 2030-110	2030	2	110	2972	941	1191	895	1420	2.2	1.1
MRC 2030-120	2030	2.5	120	2972	941	1191	895	1455	2.2	1.1
MRC 2030-130	2030	3	130	2972	941	1191	895	1492	2.2	1.1
MRC 2030-140	2030	3.5	140	2972	941	1191	895	1565	2.2	1.1
MRC 2530-140	2530	2.5	140	3472	941	1191	895	1658	2.2	1.1

The mentioned values above is only works for 260 N/mm²
 Different material and widths ; can be calculated with ANERKA Roll Bending Calculator
 Conic bending capacities depends on the angle and half value of mentioned values above
 Weight and motor powers may increase with optional features.
 Due to ongoing product development, specifications may change at any time

MRD

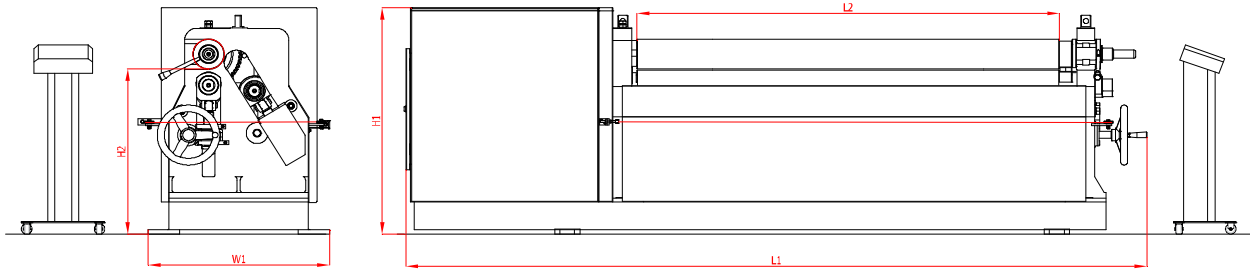

TYPE	Bending Length	Bending Capacity					Working Height		Main Motor Power	Back Roll Motor Power (Optional)
	L2 (mm)	T (mm)	Ød (mm)	L1 (mm)	W (mm)	H1 (mm)	H2 (mm)	(kg)	(kW)	(kW)
MRD 1030-150	1030	6	150	2559	870	1130	824	2170	4	3
MRD 1030-160	1030	7	160	2559	870	1130	824	2250	4	3
MRD 1030-170	1030	8	170	2559	870	1130	824	2345	4	3
MRD 1030-180	1030	9	180	2559	870	1130	824	2445	4	3
MRD 1280-150	1280	5.5	150	2809	870	1130	824	2300	4	3
MRD 1280-160	1280	6	160	2809	870	1130	824	2390	4	3
MRD 1280-170	1280	7	170	2809	870	1130	824	2490	4	3
MRD 1280-180	1280	8	180	2809	870	1130	824	2595	4	3
MRD 1530-150	1530	4.5	150	3059	870	1130	824	2215	4	3
MRD 1530-160	1530	5	160	3059	870	1130	824	2320	4	3
MRD 1530-170	1530	6	170	3059	870	1130	824	2440	4	3
MRD 1530-180	1530	7	180	3059	870	1130	824	2560	4	3
MRD 2030-150	2030	4	150	3559	870	1130	824	2470	4	3
MRD 2030-160	2030	4.5	160	3559	870	1130	824	2590	4	3
MRD 2030-170	2030	5	170	3559	870	1130	824	2675	4	3
MRD 2030-180	2030	6	180	3559	870	1130	824	2830	4	3
MRD 2530-150	2530	3	150	4059	870	1130	824	2700	4	3
MRD 2530-160	2530	4	160	4059	870	1130	824	2785	4	3
MRD 2530-170	2530	4.5	170	4059	870	1130	824	2935	4	3
MRD 2530-180	2530	5	180	4059	870	1130	824	3125	4	3
MRD 3050-160	3050	3	160	4559	870	1130	824	3750	4	3
MRD 3050-180	3050	4	180	4559	870	1130	824	4250	4	3

The mentioned values above is only works for 260 N/mm²

Different material and widths ; can be calculated with ANERKA Roll Bending Calculator

Conic bending capacities depends on the angle and half value of mentioned values above

Weight and motor powers may increase with optional features.

Due to ongoing product development, specifications may change at any time

STANDARD (MRA Series)

- Top and bottom rolls are powered by a helical type gear-box and AC motor
- AISI 1050 Quality Certificated steel rolls with high tensile strength
- Solid steel frame.
- Mechanical manual mechanical drop-end.
- Foot pedal.
- Conical bending device
- Manual lubrication points
- Manual pinching
- Wire grooves at the end of the rolls (7, 9,11,13 mm)

STANDARD (MRB Series)

- Top and bottom rolls are powered by a helical type gear-box and AC motor
- AISI 1050 Quality Certificated steel rolls with high tensile strength
- Solid steel frame.
- Mechanical manual mechanical drop-end.
- Foot pedal.
- Conical bending device
- Manual lubrication points
- Manual pinching
- Wire grooves at the end of the rolls (7, 9,11,13 mm)

STANDARD (MRC Series)

- Top and bottom rolls are powered by a helical type gear-box and AC motor
- AISI 1050 Quality Certificated steel rolls with high tensile strength
- Solid steel frame.
- Mechanical manual mechanical drop-end.
- Mobile control panel
- Conical bending device
- Manual lubrication points
- Manual pinching with handweel

STANDARD (MRD Series)

- Top and bottom rolls are powered by a helical type gear-box and AC motor
- AISI 1050 Quality Certificated steel rolls with high tensile strength
- Solid steel frame.
- Mechanical manual mechanical drop-end.
- Mobile control panel
- Conical bending device
- Manual lubrication points
- Manual pinching with handweel
- Motorised adjustment of back roll

OPTIONAL (MRA Series)

- Digital Read-Out for rear (back) roll
- Induction hardened and polished rolls
- Motorised adjustment of back roll

OPTIONAL (MRB Series)

- Digital Read-Out for rear (back) roll
- Induction hardened and polished rolls
- Motorised adjustment of back roll

OPTIONAL (MRC Series)

- Digital Read-Out for rear (back) roll
- Induction hardened and polished rolls
- Motorised adjustment of back roll
- Extended roll shafts for profile and pipe bending operations
- Profile and section bending rolls set
- Segmented plastic rolls for composite bending

OPTIONAL (MRD Series)

- Digital Read-Out for rear (back) roll
- Induction hardened and polished rolls
- Extended roll shafts for profile and pipe bending operations
- Profile and section bending rolls set
- Motorised bottom roll (pinching)
- Segmented plastic rolls for composite bending

VMR

VARIABLE GEOMETRY MOTORIZED THREE ROLL
FUSELAGE PANELS AND WING EDGE BENDING MACHINE



Multi radius bending

We have designed and produced VMR series machines to meet the needs of aircraft and helicopter parts manufacturers in the USA. Basically this machine is a mixture of press brake and roll bending machine. The VMR series machines allows very precise and fast forming of aluminum and titanium sheets with cylindrical, hyperbolic or conical form. With our expert R&D team, we can produce special solutions to solve any problems specific to your project.



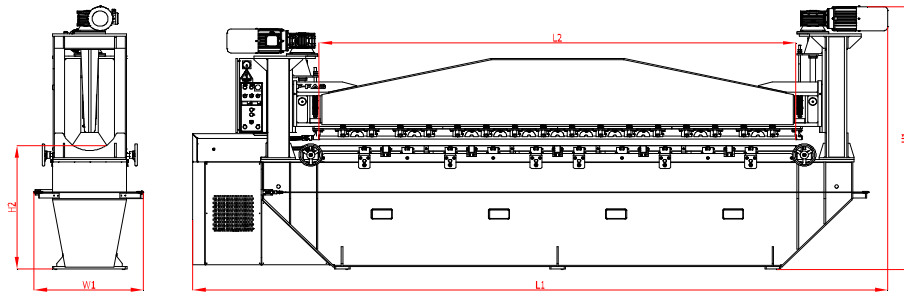

TYPE	Bending Length L2 (mm)	Bending Capacities				Upper Roll Ød (mm)	Lower Rolls Ø (mm)	Max. Pass Through A (mm)	Length L1 (mm)	Width W1 (mm)	Height H1 (mm)	Working Height H2 (mm)	Weight (Kg)	Motor Power (Kw)
		Aluminium 5754-H22 Capacities T (mm)	Aluminium 6061-T6 Capacities T (mm)	Mild Steel Capacities T (mm)	Titanium 6242 Capacities T (mm)									
		T (mm)	T (mm)	T (mm)	T (mm)									
VMR 2050-25	2050	2.00	1.60	2.00	1.30	25	45	50	3530	860	2130	1000	1950	4.50
VMR 3100-25	3100	1.60	1.30	1.50	0.80	25	45	50	4750	860	2130	1000	2650	4.50
VMR 4100-25	4100	1.60	1.30	1.50	0.80	25	45	50	5800	860	2130	1000	3000	4.50
VMR 5100-25	5100	1.30	1.00	1.20	0.60	25	45	50	6350	860	2130	1000	3700	4.50
VMR 6100-25	6100	1.30	1.00	1.20	0.60	25	45	50	7800	860	2130	1000	4400	4.50
VMR 3100-38	3100	4.00	3.00	3.00	1.60	38	50	75	4750	860	2130	1000	4700	6.60
VMR 4100-38	4100	4.00	3.00	3.00	1.60	38	50	75	5800	860	2130	1000	5300	6.60
VMR 5100-38	5100	3.00	2.00	2.00	1.30	38	50	75	6350	860	2130	1000	6400	6.60
VMR 6100-38	6100	3.00	2.00	2.00	1.30	38	50	75	7800	860	2130	1000	7600	6.60
VMR 3100-50	3100	6.00	5.00	4.50	2.50	50	60	75	4830	1120	2440	1000	6800	9.00
VMR 4100-50	4100	6.00	5.00	4.50	2.50	50	60	75	5880	1120	2440	1000	7600	9.00
VMR 5100-50	5100	5.00	4.00	4.00	2.00	50	60	75	6430	1120	2440	1000	9200	9.00
VMR 6100-50	6100	5.00	4.00	4.00	2.00	50	60	75	7880	1120	2440	1000	10800	9.00

- Larger machines available, please contact with us.
- All specifications are subject to change without notice.
- Weight and motor powers optionally goes higher levels with additional features.
- Due to ongoing product development, specifications may change at any time.

Larger or Custom Machines Available

STANDARD

- Digital readout
- Dual speed
- Induction hardened rolls (HRC 54-58)
- AISI 1050 Carbon steel rolls ground and chrome coated.
- Upper beam is powered by separate dual speed AC motors, gearboxes, screw jacks and zero backlash couplings
- Machine body constructed of stress-relieved high yield steel
- Rolls seated in bronze roller bushings
- All rolls driven by AC motor and helical gear box with cardan shafts
- Emergency stop wire around the machine
- Electrical and mechanical protection against over-loads
- World standard electrical components (parts stocked by ANERKA or available off-the shelf from your local supplier)
- Manual lubrication

OPTIONAL

- NC Control Unit
- Motorized bottom rolls
- Motorized and NC controlled bottom rolls
- All axis positioning with adjustable speed on NC machines
- Hydraulic side support system (both sides)
- Material feeding table (Idle or motorized)
- Automatic central lubrication
- Automation systems

SMR

NUMERIC CONTROLLED VARIABLE GEOMETRY SERVO DRIVEN THREE ROLLS FUSELAGE PANELS AND WING EDGE BENDING MACHINE



Aircraft and Aerospace projects require superb precision and repeatability and the ANERKA SMR series can make it easy to reliably form part after part that you can count on.

ADVANTAGES

Superior springback control on thin, high yield materials, by using precise roll positioning and narrow roll geometry. This allows for almost flawless repeatability on even hard to form pieces.

Gearbox disc braking system allows for perfect press bending without allowing the material to slide.

Excessive upper beam daylight lets you easily remove parts.

Portable NC control unit moves with you so you can monitor the forming process anywhere in the work area. Independent tiltable infeed and outfeed tables provide support to protect your forming radius.

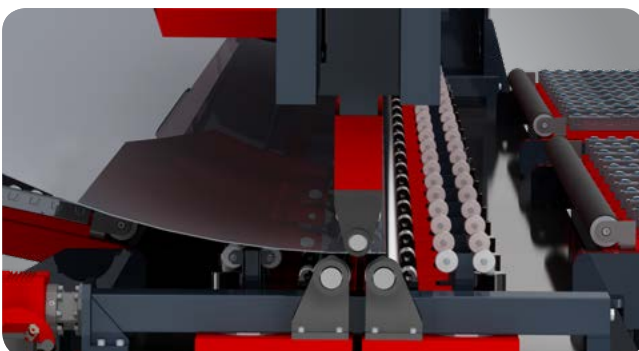

CUSTOM SOLUTIONS

Since 1999, we've specialized in designing and building innovative, custom sheet metal forming machines that transform mere concepts into solutions. We provide our customers with custom-engineered solutions, specifically optimized for their particular application. This careful focus on our clients' needs continues to contribute to our reputation for producing well-crafted machinery that addresses difficult automation situations, resulting in higher productivity and profit for the end user. While we have specialized for decades in machinery for plate roll and profile roll bending machines, we also provide solutions in other industries that rely on the type of design and manufacturing expertise we possess.

AUTOMATIC LIQUID TANK BENDING LINES

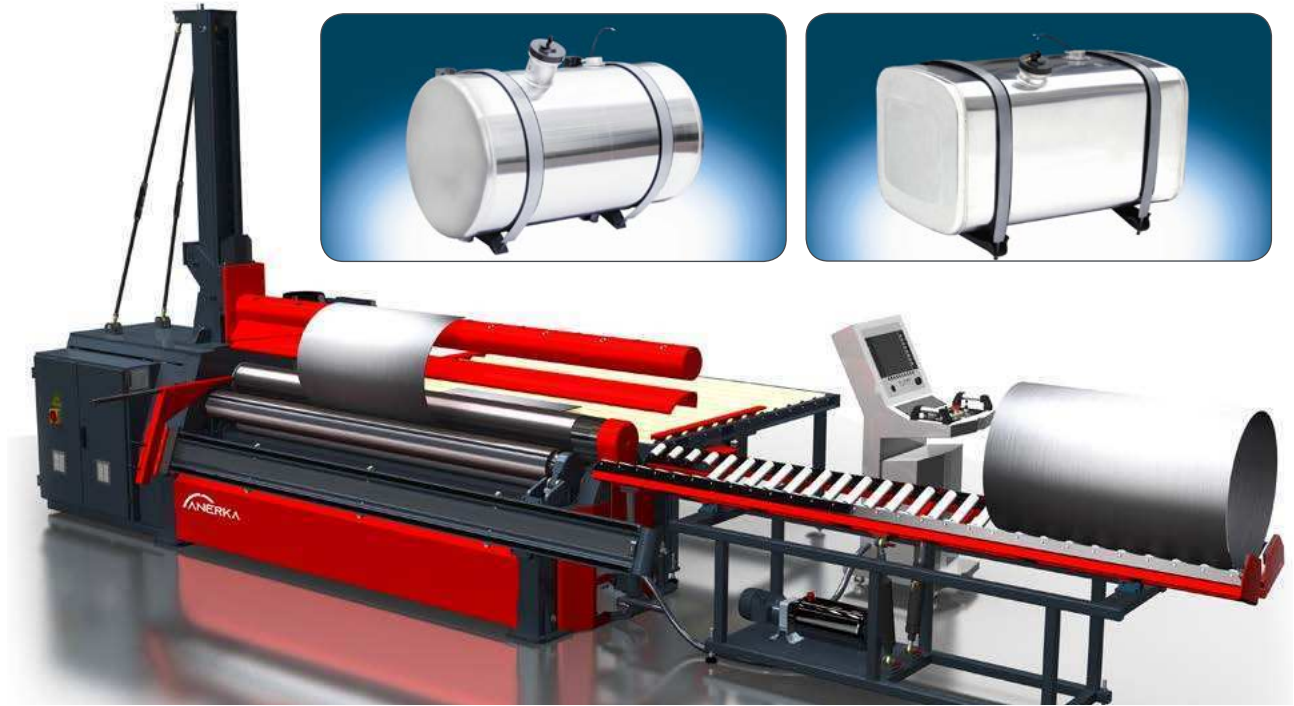

WIND TOWER BENDING LINES



PIPE BENDING SOLUTION

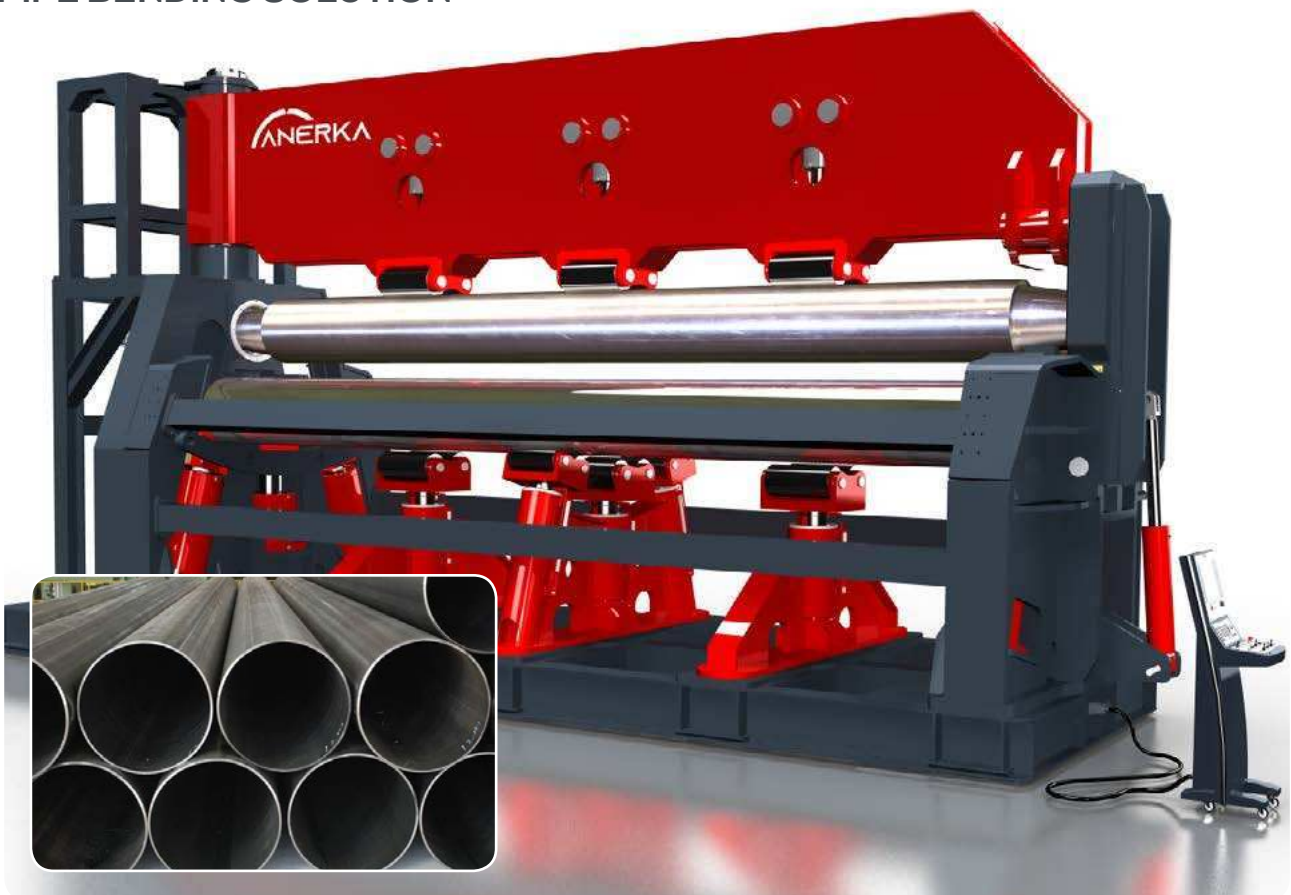

VERTICAL BENDING SOLUTIONS

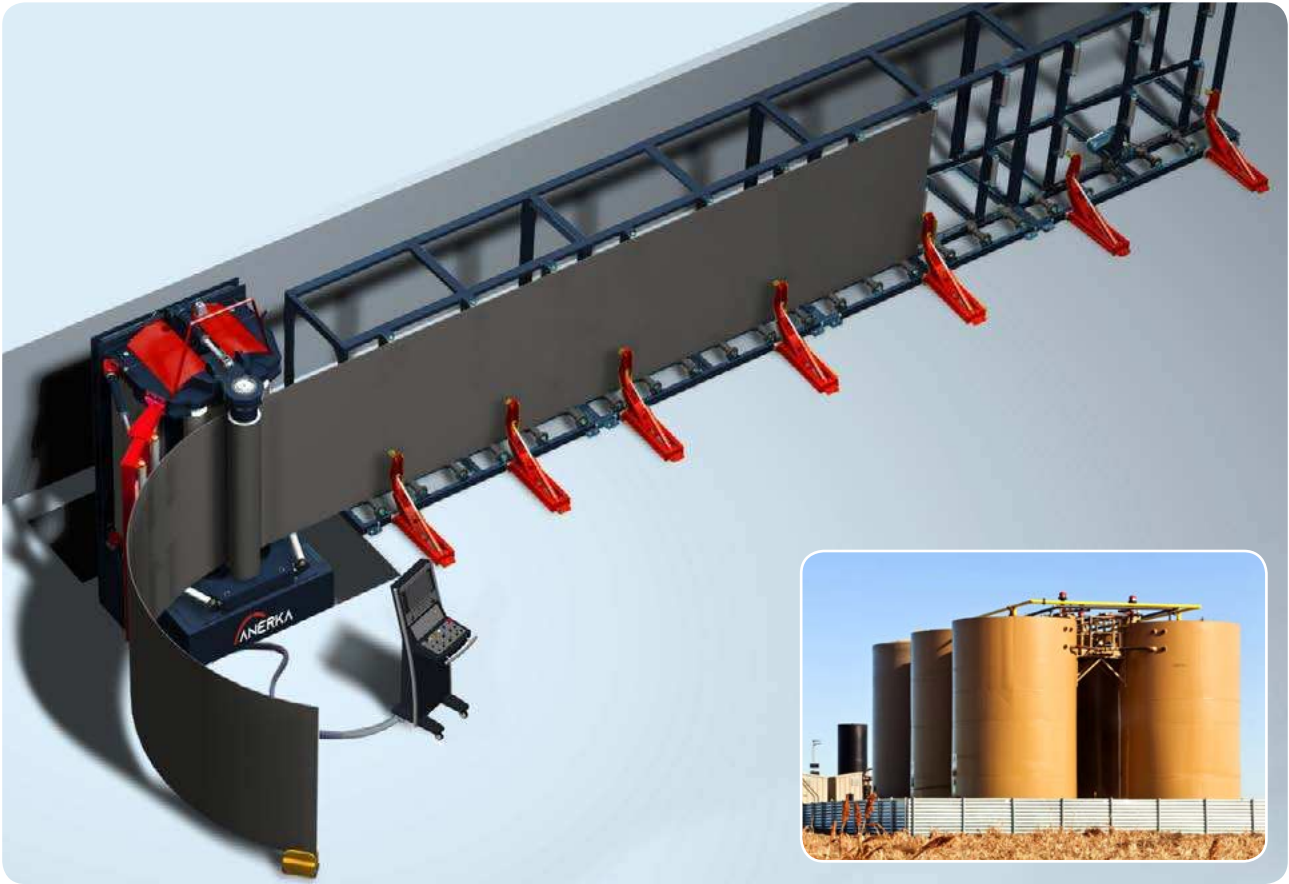

SPACE ROCKET FUEL TANK BENDING MACHINE



Our team at ANERKA has developed some very unique / amazing solutions for the aerospace industry.

ISOGRID & ORTHOGRID BENDING SOLUTIONS FOR SPACECRAFTS

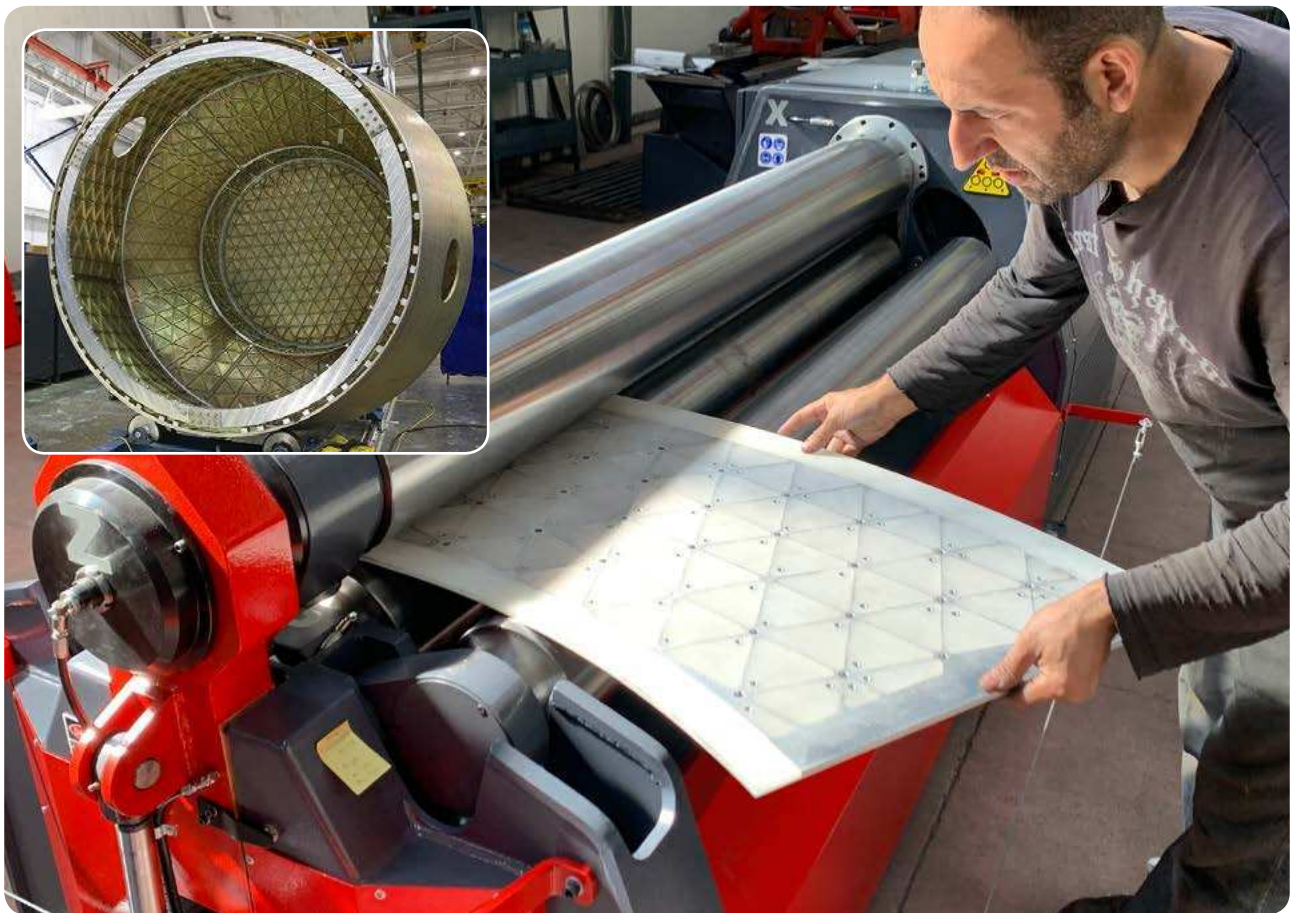

WE ALSO RETROFIT OLD MACHINES

We also make plate roll retrofit projects. We have designed and manufactured a brand new hydraulic and electrical system for these "scrap" plate rolls. We adapt the new gearboxes, hydraulic system and electrical panel into the machine at customer site. If required, we can convert any brand of roll bending machine to NC or CNC. Please consult us before you sell your old machine at auction.

BEFORE



AFTER





Plate Rolls

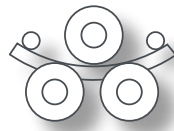

Angle Rolls

*"If you need a machine and don't buy it, you'll find that you have paid for it anyway, but don't have it."
Henry Ford*



Capital Machinery Sales Pty Ltd
www.capitalmachinery.com.au
Call: 1800706620

For more information about this machinery or to enquire about a quotation please contact us by emailing sales@capitalmachinery.com.au or by calling **1800 706 620**